

Exodus 4W Series

12V/4-Wire Fire Detectors with Built-in Relay for Connection to Security Panels

INSTRUCTIONS

OH/4W
4-WIRE OPTICAL SMOKE & HEAT MULTISENSOR

FT64/4W
4-WIRE FIXED 64°C HEAT DETECTOR

RR/4W
4-WIRE RATE OF RISE HEAT DETECTOR

FT90/4W
4-WIRE FIXED 90°C HEAT DETECTOR

Texecom
www.texecom.com

NS 243-2

QUALITY ASSURANCE



Certificate Number: FM 35285



British Security Industry Association



British Security Industry Association

WARRANTY

5 year replacement warranty.

The Exodus 4W Series is designed to detect the presence of fire and activate an alarm control panel. As the Exodus 4W Series is not a complete alarm system, but only a part thereof, Texecom cannot accept responsibility or liability for any damages whatsoever based on a claim that the Exodus 4W Series failed to function correctly. These instructions are intended as a guide only. Always consult Local and National Standards where applicable.

Due to our policy of continuous improvement Texecom reserves the right to change specification without prior notice.

Document Ref: E4W/EU/1.0
© 2003 Texecom Ltd

7 CHOOSING A DETECTOR

Exodus OH/4W OPTICAL SMOKE & HEAT MULTISENSOR

Detects: 1. Large smoke particles e.g. from smouldering fires OR

2. Small smoke particles AND a small temperature increase e.g. from fast flaming fire.
- Does not alarm on heat only.

Suitable For: Fast detection for widest range of fires. Gives improved false alarm immunity compared to ionisation or optical only.

Not Suitable For: Smoky, dusty or steamy environments e.g. kitchens, bars, bathrooms.

Label colour: Blue
Designed to comply with EN54-7

1 PHYSICAL

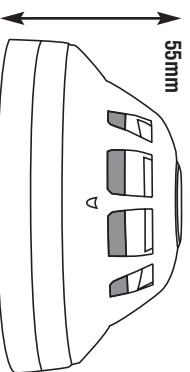
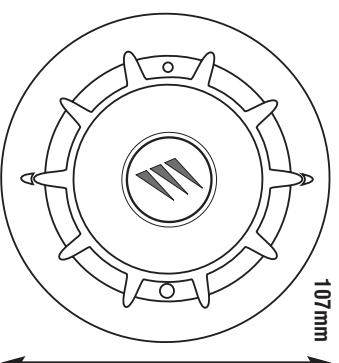

4 INDICATORS & CONTROLS

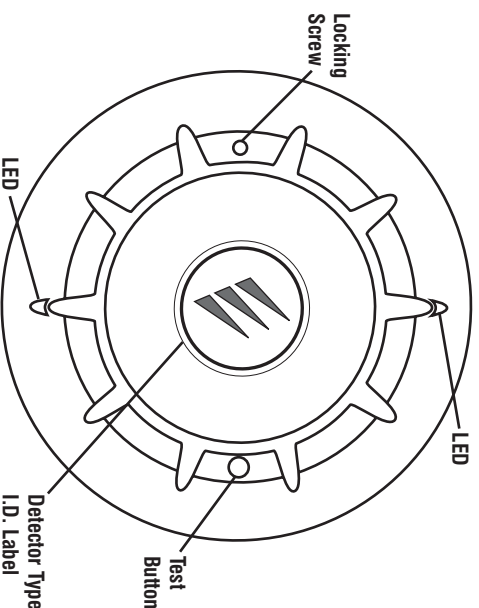

Exodus RR/4W RATE OF RISE HEAT DETECTOR

Detects: 1. Rapid increases in temperature OR

2. Temperatures above 58°C (136°F).

Suitable For: Fast fire detection in smoky or dusty environments e.g. bars or attics, where normal temperatures do not exceed 38°C (100°F).

Not Suitable For: Environments where the temperature might change rapidly, e.g. kitchens, bathrooms.

Label colour: Green
Designed to comply with EN54-5 Grade A1/R

2 ENVIRONMENTAL



Storage Temperature:
-20°C (-4°F) to +80°C (+176°F)

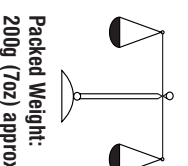

Packed Weight:
200g (7oz) approx.

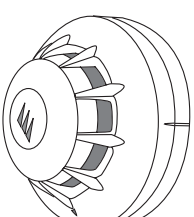

Normal Operating Temperature (i.e. non alarm state):
-10°C (+14°F) to +55°C (+131°F) (OH/4W, RR/4W, FT64/4W)
-10°C (+14°F) to +80°C (+176°F) (FT90/4W)

5 CONNECTIONS

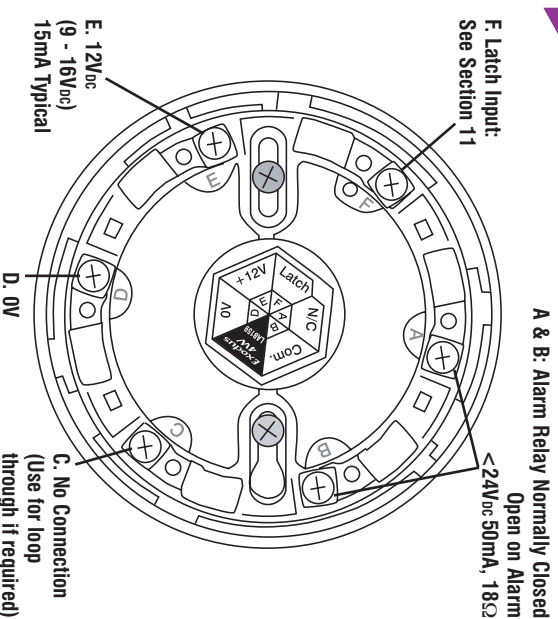

Exodus FT64/4W 64°C FIXED TEMPERATURE HEAT DETECTOR

Detects: Temperatures above 64°C (147°F).

Suitable For: Fire detection in smoky environments where rapid temperature changes might occur e.g. kitchens, bathrooms, where normal temperatures do not exceed 44°C (111°F).

Not Suitable For: Fast detection of slow burning or smouldering fires, or for use where the normal temperature exceeds 44°C (111°F).

Label colour: Orange
Designed to comply with EN54-5 Grade A2/S

3 FALSE ALARM PROTECTION

- Design:** Microcontroller based signal analysis. Electronic drift compensation.
- RF Immunity:** No false alarms from 80MHz to 1GHz at 10V/m. Complies with BS EN 61000-4-3:1997.
- Electrostatic Discharge:** No false alarms up to 8kV. Complies with BS EN 61000-4-2:1995.
- Fast Transient Immunity:** No false alarms up to ±4kV. Complies with BS EN 61000-4-4:1995.
- High Energy Transient Immunity:** No false alarms up to ±2kV. Complies with BS EN 61000-4-5:1995.
- Conducted RF Susceptibility:** No false alarms at 10V/m. Complies with BS EN 61000-4-6:1996.
- Conducted Emissions:** Complies with EN 55022 Class B.
- Radiated Emissions:** Complies with EN 55022 Class B.
- EMC:** Independently certified to EN 50130-4:1996.

6 IMPORTANT FACTS TO CONSIDER BEFORE CHOOSING THE TYPE OF SMOKE OR HEAT DETECTOR

Historically, smoke detectors have used either ionisation or optical (photo-electric) detection. Both of these technologies on their own suffer from problems.

PROBLEMS WITH 'IONISATION ONLY' DETECTORS

'Ionisation only' detectors have a poor response to large smoke particles e.g. a slow smouldering fire. They are also very sensitive to fumes which often leads to false alarms. Additionally, there are increasing environmental and health concerns over the use of radioactive sensors.

Texecom's advice is: do not fit 'ionisation only' detectors where susceptibility to false alarms is a concern.

PROBLEMS WITH 'OPTICAL ONLY' DETECTORS

'Optical only' detectors do not react well to fast flaming fires and so often have their sensitivity increased. This can lead to false alarms.

To achieve maximum false alarm immunity and excellent fire detection Texecom recommend the use of optical smoke and heat multisensors or heat detectors.

Exodus FT90/4W 90°C FIXED TEMPERATURE HEAT DETECTOR

Detects: Temperatures above 90°C (194°F).

Suitable For: Environments where temperatures up to 70°C (158°F) occur normally e.g. boiler rooms.

Not Suitable For: Fast detection of slow burning or smouldering fires.

Label colour: Red
Designed to comply with EN54 Grade C/S

8 CHOOSING A LOCATION

For Indoor Use Only

Always refer to any local or national guidelines (e.g. BS 5839-1) when choosing a suitable location. In a typical domestic installation at least one detector should be fitted for each level, usually in a central location e.g. hall or landing.[†]

In commercial installations at least one detector should be installed for each area to be protected.

Always use the most suitable detector for the environment (see Section 7).[†]

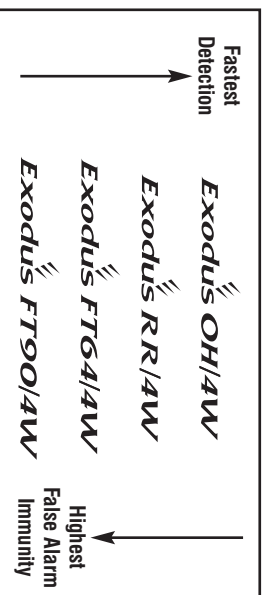

10 WIRING

The *Exodus 4W Series* are designed for connection to a security panel. See Section 5 for connections.

Connect to a 24hr fire zone on panel

A: Normally closed relay, open on detection of fire, loss of power, removal of detector or test passed.

C: No connection (can be used as 'loop through').

D: 0V } Connect to 12V auxiliary power supply on panel.

E: +12V }

F: Latch Input (see Section 11).

11 LATCH INPUT

The *Exodus 4W Series* can be configured as either auto reset or latching depending on how the Latch Input is wired.

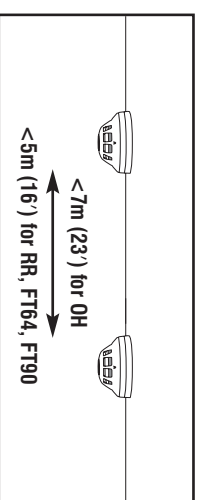

In larger rooms fit a smoke detector at least every 7m (23') or a heat detector at least every 5m (16'). Where obstructions are present additional detectors may be required.[†]

12 FITTING THE DETECTOR TO THE CEILING RING

Using the ceiling ring as a template mark out the position and drill two holes. When fitting to suspended ceiling tiles it may be helpful to place a piece of wood above the tile to screw into.

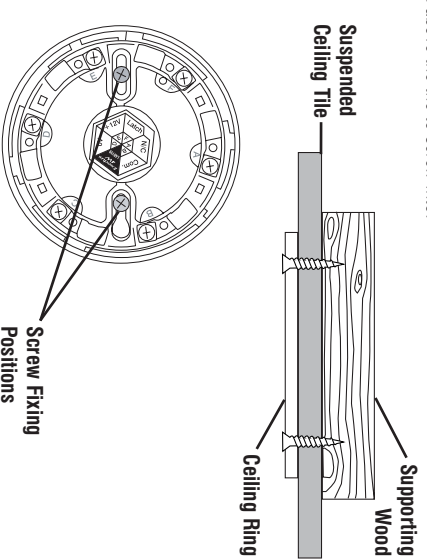

Avoid Common False Alarm Sources

For optical and heat multisensors do not install near sources of steam, condensation or smoke (e.g. from cigarettes).

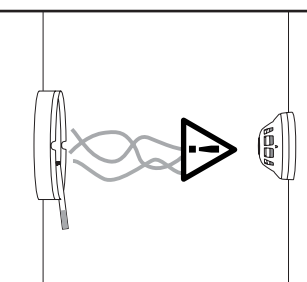

For heat detectors do not install close to natural heat sources (e.g. above a cooker or fire place).

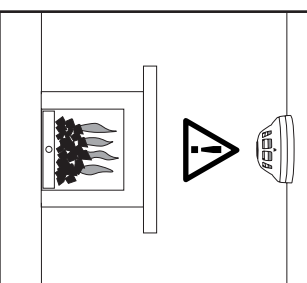

13 REMOVE DUST COVER BEFORE COMMISSIONING

The *Exodus 4W Series* comes fitted with a protective dust cover. This is to prevent dust and dirt getting into the detector and affecting the sensitive electronics. The cover should be kept in place during installation and while any building work is done.

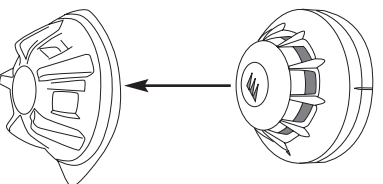

The cover must be removed before the detector is made operational.

14 COMMISSIONING & TESTING

IMPORTANT:
A latched detector is held in alarm state and cannot signal a new occurrence of a fire until it has been reset. Always ensure detectors are reset following an activation. Instruct the end user accordingly.

Latch Input:

No Connection or 0V: Auto reset (detector automatically resets after the smoke or heat has gone).

+12V: Latching (after a detection the unit will stay in alarm until power is removed or the Latch Input is taken momentarily low).

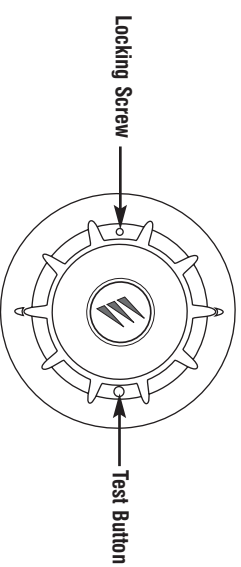

After applying power allow 1 minute for the detector to adjust to its environment. During normal operation of the detector the LEDs will blink every 8 seconds. After 1 minute press and hold the test button. The LEDs should light and the relay open. Confirm that the panel has detected the relay opening. The test button checks that the optical chamber is working correctly on the *Exodus OH/4W*, and that the thermistor is present on all models.

12 FITTING THE DETECTOR TO THE CEILING RING

1. Push the detector upwards against the ceiling ring.
2. Rotate the detector clockwise until it clicks firmly into place.
3. To lock the detector head in place turn the hexagonal locking screw clockwise several times, using a 1.5mm hexagonal key.

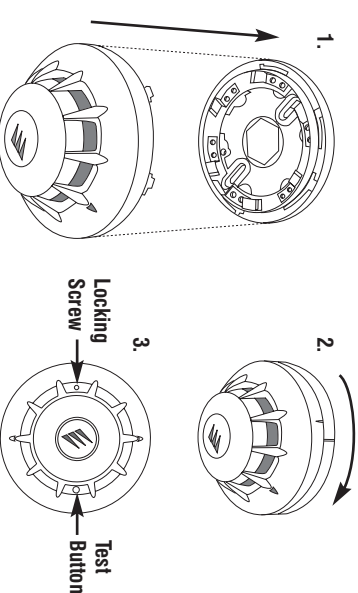

CAUTION:

1. Never paint the *Exodus* detectors. Always instruct the end user not to paint the detectors, and ensure that they remain dust free.
2. Excessive dust build up can lead to increased sensitivity and false alarms. The *Exodus OH/4W* incorporates electronic drift compensation to reduce the effects of dust build up however excessive exposure should be avoided. Always cover or remove the detector during any building work. Be sure to uncover or replace the detector on completion. Instruct the end user accordingly.

Always refer to local guidelines for test requirements and strategies.

Ideally the *Exodus OH/4W* should be tested with smoke. Specially designed smoke test units are available. The *Exodus RR/4W*, *FT64/4W* and *FT90/4W* can be tested with a hot air gun. Care should be taken not to damage the plastic.

Detectors should be tested on a regular basis.[†] Ensure latching detectors are reset after testing.

In normal operation the detection LEDs blink momentarily every 8 seconds. The microprocessor automatically compensates for a gradual increase in scatter signal due to contamination e.g. dust build up. If excessive dust occurs or the micro fails its automatic self test then the LED will blink every 2 seconds. In these circumstances remove the detector head and vacuum around the outside of the mesh (do not disassemble the detector). If this fails to cure the problem, the detector should be replaced.

[†] Always refer to any local or national standards (e.g. BS 5839-1) for requirements and recommendations.