

DS-2CE59H8T-(A)VPIT3ZF 5 MP Dome Camera



Key Features

- 5 MP high performance CMOS
- Auto focus
- 2560 × 1944 resolution
- 2.7 mm to 13.5 mm motorized vari-focal lens
- EXIR 2.0, smart IR, up to 60 m IR distance
- OSD menu, 3D DNR, 130 dB true WDR
- 4 in 1 video output (switchable TVI/AHD/CVI/CVBS)
- IP67, IK10
- Up the coax (HIKVISION-C)



Specification

| Camera | |
|------------------------------|--|
| Image Sensor | 5 megapixel progressive scan CMOS |
| Signal System | PAL/NTSC |
| Resolution | 2560 (H) × 1944 (V) |
| Min. Illumination | Color: 0.003 Lux@(F1.2, AGC ON), 0 Lux with IR |
| Frame Rate | TVI: 2 MP@25fps, 2 MP@30fps, 4 MP@25fps, 4 MP@30fps, 5 MP@20fps AHD: 4 MP@25fps, 4 MP@30fps, 5 MP@20fps CVI: 4 MP@25fps, 4 MP@30fps CVBS: PAL, NTSC |
| Shutter Time | PAL: 1/25 s to 1/50,000 s NTSC: 1/30 s to 1/50,000 s |
| Lens | 2.7 mm to 13.5 mm motorized vari-focal lens |
| Horizontal Field of View | 92.3° to 29.3° |
| Lens Mount | Φ 14 |
| Day & Night | IR cut filter |
| Angle Adjustment | Pan: 0° to 355°; Tilt: 0° to 75°; Rotate: 0° to 355° |
| Synchronization | Internal synchronization |
| WDR (Wide Dynamic Range) | ≥ 130 dB |
| Menu | |
| AGC | Yes |
| Day/Night Mode | Auto/Color/BW (Black and White) |
| White Balance | Auto/Manual |
| BLC (Backlight Compensation) | Yes |
| WDR | Yes |
| 3D DNR | Level 1 to 9 |
| Privacy Mask | 4 programmable privacy masks |
| Motion Detection | 4 programmable areas |
| Language | English |
| Functions | Brightness, Sharpness, 3D DNR, Mirror, Smart IR |
| Interface | |
| Video Output | 1 HD analog output |
| Switch Button | TVI/AHD/CVI/CVBS |
| General | |
| Operating Conditions | -40 °C to 60 °C (-40 °F to 140 °F), humidity: 90% or less (non-condensation) |
| Power Supply | 9 VDC to 15 VDC -A: 9.6 VDC to 14.4 VDC; 19.2 VAC to 28.8 VAC |
| Power Consumption | Max. 5.7 W -A: Max. 8 W |
| Protection Level | IP67, IK10 |
| Material | Metal |
| IR Range | Up to 60 m |
| Communication | Up the coax, Protocol: HIKVISION-C (TVI output) |
| Dimensions | Ø 145.2 mm × 124.1 mm (Ø 7.1" × 4.9") |
| Weight | Approx. 610 g (1.35 lb.) -A: Approx. 640 g (1.41 lb.) |

Order Model

DS-2CE59H8T-AVPIT3ZF, DS-2CE59H8T-VPIT3ZF

Dimension

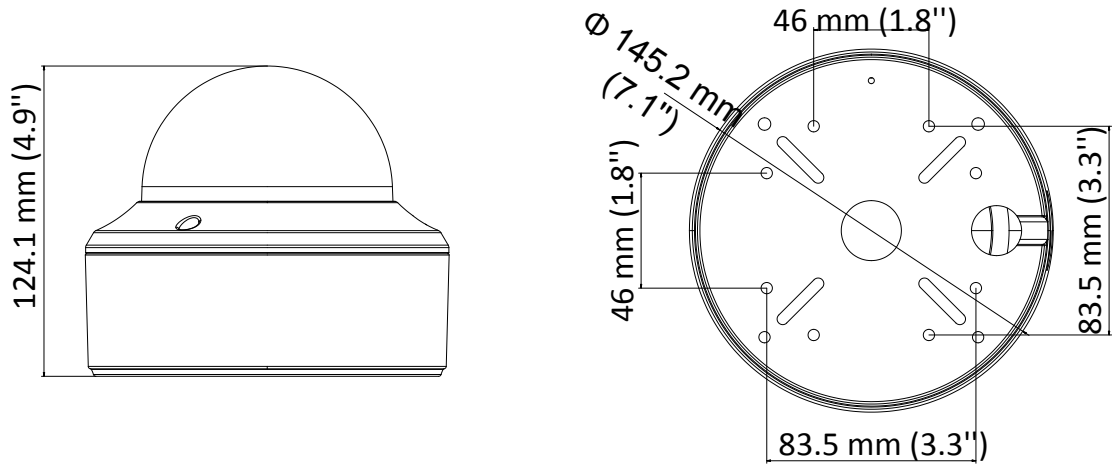

Accessory

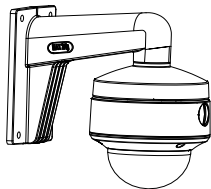

DS-1273ZJ-140
Wall Mount

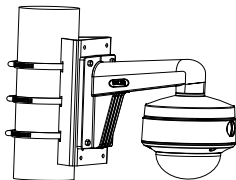

DS-1275ZJ-SUS
Vertical Pole Mount

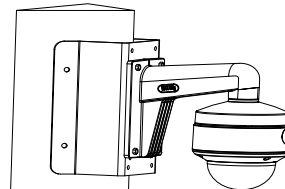

DS-1276ZJ-SUS
Corner Mount

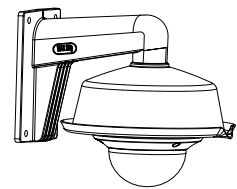

DS-1253ZJ-L
Rain Shade

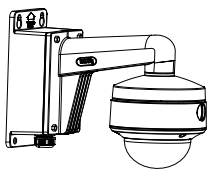

DS-1273ZJ-140B
Wall Mount

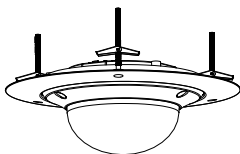

DS-1241ZJ
In-ceiling Mount

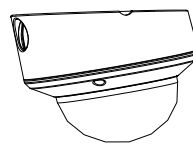

DS-1240ZJ
Inclined Ceiling Mount

Distributed by



HIKVISION®

Headquarters

No.555 Qianmo Road, Binjiang District,
Hangzhou 310051, China
T +86-571-8807-5998
overseasbusiness@hikvision.com

Hikvision USA
T +1-909-895-0400
sales.usa@hikvision.com

Hikvision Europe
T +31-23-55-42-770
info.eu@hikvision.com

Hikvision Middle East
T +971-4-8816086
salesme@hikvision.com

Hikvision Russia
T +7-495-669-67-99
saleru@hikvision.com

Hikvision India
T +91-22-28469900
sales@pramahikvision.com

Hikvision Italy
T +39-0438-6902
info.it@hikvision.com

Hikvision France
T +33(0)1-85-330-450
info.fr@hikvision.com

Hikvision Spain
T +34-91-737-16-55
info.es@hikvision.com

Hikvision Poland
T +48-22-460-01-50
poland@hikvision.com

Hikvision UK
T +01628-902140
support.uk@hikvision.com

Hikvision Singapore
T +65-6684-4718
sg@hikvision.com

Hikvision Oceania
T +61-2-8599-4233
salesau@hikvision.com

Hikvision Canada
T +1-909-895-0400
sales.usa@hikvision.com

Hikvision Korea
T +82-31-731-8841
sales.korea@hikvision.com

Hikvision Brazil
T +55 11 3318-0050
Latam.support@hikvision.com

Hikvision Africa
T +27 (0) 0351172
sale.africa@hikvision.com

Hikvision Hong Kong
T +852-2151-1761