

PFB203W

Water-proof Wall Mount Bracket



Features

- Material: Aluminum
- Wall Mount Bracket
- Neat & Integrated design

Specifications

Model	PFB203W
General	
Material	Aluminum
Dimension (L x W x H)	160mm x 122mm x 76mm
Operating Temperature	-40°C~60°C
Humidity	0~90% RH
Load Bearing	1.0Kg
Weight	0.50Kg
Color	White
Applicable Model	Please see "Accessory Selection"

PFB203W

Dimensions (mm)

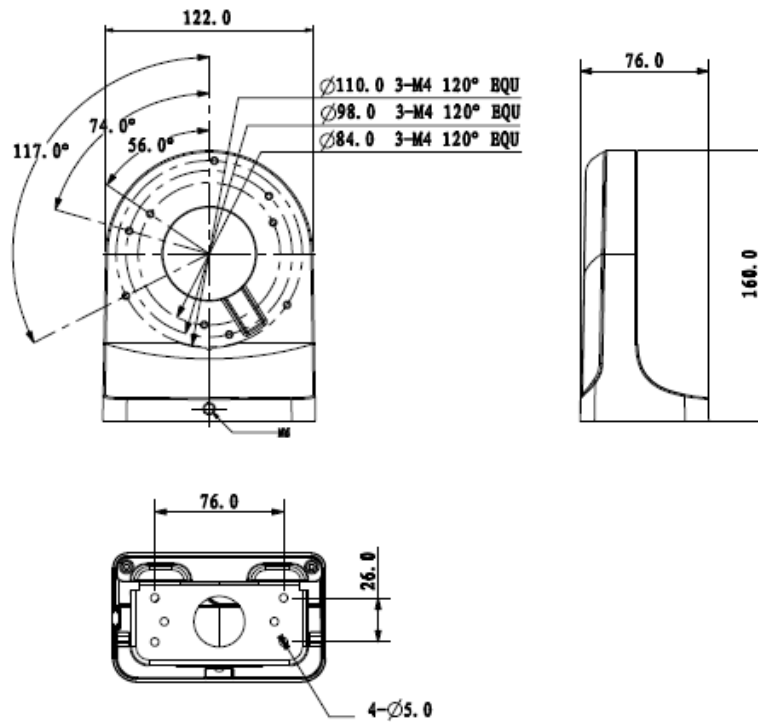

Application

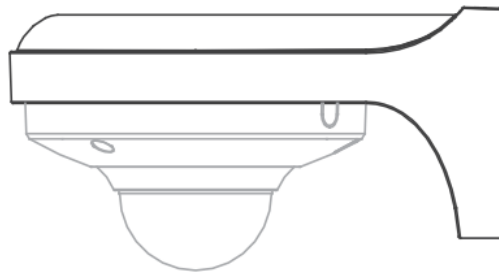

Dahua Technology Co., Ltd.

1199BinAn Road, Binjiang District, Hangzhou, China

Tel: +86-571-87688883

Fax: +86-571-87688815

Email: overseas@dahuatech.com

www.dahuasecurity.com

*Design and specifications are subject to change without notice.

© 2013Dahua Technology Co., Ltd.