

Manual EN

Handleiding NL

Manuel FR

Anleitung DE

Manual ES

Manual SE

IT

Appendix

IMPORTANT

Always connect the batteries first.

Use for 12V battery system only 12V
(36 cells) solar panel array.

Use for 24V battery system only 24V
(72 cells) solar panel array.

Use for 48V battery system only 2x24V
(72 cells) solar panel array in series.

BlueSolar PWM Charge Controller – LCD - USB

12V | 24V | 30A

48V | 10A

48V | 20A

48V | 30A

EN

NL

FR

DE

ES

SV

IT

Appendix



IMPORTANT

Always connect the batteries first.

- Use for 12V battery system only 12V (36 cells) solar panel array.
- Use for 24V battery system only 24V (72 cells) solar panel array.
- Use for 48V battery system only 2x24V (72 cells) solar panel array in series.

1. General Information

The BlueSolar Charge Controller series uses Pulse Width Modulation (PWM) charge voltage control combined with a multistage charge control algorithm.

2. Features

- Three stage battery charging [bulk – absorption – float]
- Battery type: Lead-ACID and LiFePO4 (with internal BMS)
- Protected against over current.
- Protected against short circuit.
- Protected against reverse polarity connection of the solar panels and/or battery.
- Low voltage load disconnect.
- Temperature protection.

3. Installation

Important note: Always connect the batteries first.

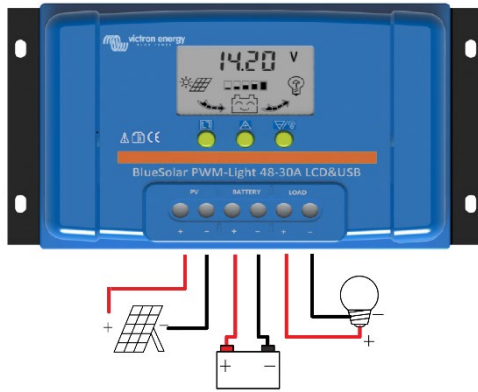

1. Connect the battery to the charge regulator - plus and minus.
2. Connect the solar module to the regulator - plus and minus.
3. Connect the load to the charge regulator - plus and minus.

The reverse order applies when deinstalling!

An improper sequence order can damage the BlueSolar Charge Controller!

1. Make sure your battery is charged for the BlueSolar Charge Controller to recognize the battery type before first installation.
2. The battery cable should be as short as possible to minimize losses.
3. The BlueSolar Charge Controller is only suitable for lead-acid, and LiFePO4 batteries.
4. The BlueSolar Charge Controller is only suitable for regulating solar modules. Never connect another charging source to the charge BlueSolar Charge Controller.



victron energy

4. LCD DISPLAY and SETTINGS

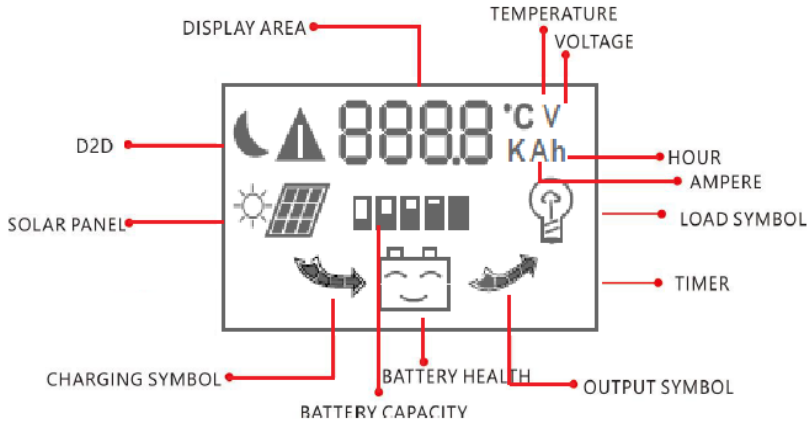

MENU: switch between different display, or to enter/exit setting by long press.



UP: press to change the settings when in setting mode.



DOWN: press to change the settings when in setting mode.
Load on/off button when in H mode.

4.1 Monitoring & Settings

Values between [] are for 24V battery settings. **Bolt** are the 48V settings.



Boot Display. After connecting the batteries, you see the type of charger and the measured battery voltage.

1230= BlueSolar Charge Controller – LCD – USB 12V|30A

2430= BlueSolar Charge Controller – LCD – USB 24V|30A

4810= BlueSolar Charge Controller – LCD – USB 48V|10A

4820= BlueSolar Charge Controller – LCD – USB 48V|20A

4830= BlueSolar Charge Controller – LCD – USB 48V|30A

Press MENU  to enter next display.



Main display. It shows battery voltage, battery capacity, charging and discharging status.
Press MENU  to enter next display.

Change Settings Main display. press on the MENU  key for several seconds until the numbers flash, you are in:



Battery type setting.
See table below.

The factory setting is b01

	Battery type	Battery voltage	Absorbtion voltage	Float voltage	Low voltage disconnect factory setting	Low voltage disconnect range	Low voltage reconnect factory setting	Low voltage reconnect range
b01	LEAD-ACID [AGM]	12.0V [24V] 48V	14.4V [28.8V] 57.6V	13.7V [27.4V] 54.8V	11.2V [22.4V] 44.8V	10.5V-12.0V in steps of 0.1V	12.6V [25.2V] 50.4V	12.0V-13.5V in steps of 0.1V
b02	LEAD-ACID [Gel]	12.0V [24V] 48V	14.2V [28.4V] 56.8V	13.7V [27.4V] 54.8V	11.2V [22.4V] 44.8V	10.5V-12.0V in steps of 0.1V	12.6V [25.2V] 50.4V	12.0V-13.5V in steps of 0.1V
b03	LEAD-ACID [Wet]	12.0V [24V] 48V	14.6V [29.2V] 58.4V	13.7V [27.4V] 54.8V	11.2V [22.4V] 44.8V	10.5V-12.0V in steps of 0.1V	12.6V [25.2V] 50.4V	12.0V-13.5V in steps of 0.1V
b04*	12V LiFePO4	12.8V	14.2V	13.35V	11.2V	10.5V-12.0V in steps of 0.1V	12.6V	12.0V-13.5V in steps of 0.1V
b05*	24V LiFePO4	25.6V	28.4V	26.7V	22.4V	21.0V-24.0V in steps of 0.1V	25.2V	24.0V-27.0V in steps of 0.1V

*The controllers do not have a remote on/off input. Therefore use LiFePO4 batteries with integrated BMS only (such as the Victron SuperPack batteries)

NA for 48V

press on the MENU  key again and you are in:



Low voltage disconnect
The factory setting is 11.2V [22.4V] **44.8V**

press on the MENU  key again and you are in:



Low voltage reconnect
The factory setting is 12.6V [25.2V] **50.4V**



Solar Voltage display. It shows Solar Panel voltage, battery capacity status.

Press MENU  to enter next display.





Charge current display. It shows solar to battery current and charge status.

Press MENU  to enter next display.



Load working mode.
The factory setting is 24H

Press MENU  to enter next display.

Change Settings in the Load working mode display.

Press on the MENU  key for several seconds until the numbers flash, you are in setting mode for the:



Load working mode setting.
See table below.

H	The load can switch on and off by the  Load on/off switch.
L	Load D2D. The load will switch on at sunset and switch off at sunrise.
L01-L23	The load output will switch on after sunset and switch off after 1-23 hours.
24H	The BlueSolar Charge Controller will continuously supply power to your load.

Press on the MENU  key again and you go to:

(Note: the Phoenix VE.Direct inverters can be controlled by connecting to the left side connection of the remote control to the load output)



Load Setting: trigger value
(Solar Panel Voltage)

When the work mode is L01-L23 the charge Controller will measure the solar panel voltage to decide whether its day or night to switch load on or off. The higher this value is the earlier it switches on the load output.

The factory setting is 4/8V/16V

Press on the MENU  key again and you go to:



L01-L23 trigger delay value
(Seconds)

When the charge Controller measures a solar panel voltage lower this value it will delay for

Press on the MENU  key again and you go to:



10s and measure again to make sure night falls. The factory setting is 10sec
Short-circuit protection setting.

Some inductive or capacitive consumer will trigger the short-circuit protection during start up. Therefore the SC-protection can be disabled manually. Sc.F=OFF, Sc.n=ON. The default is ON. The factory setting is Sc.n.



Load current display. It shows load current and battery capacity.

Press MENU  to enter next display.



USB Voltage display. It shows the USB voltage 5V (2A max)

Press MENU  to enter next display.



Controller temperature display. If the controller overheats it will automatic shut down and wait for the temperature to drop to normal level and then it will start again.

Press Press MENU  to enter Main display.



5. Alarms

High temperature

Temp <85°C, controller works normally.

When temp $\geq 85^\circ\text{C}$, controller will adopt first protection phase:

1. Controller will lower the PV input current, in order to lower the controller temp; but Load works normally. There is no alarm on LCD display.

When temp is $>90^\circ\text{C}$, controller will adopt second protection phase:

2. Controller will cut off PV input current. Load output cut off. A high temp alarm icon will show on LCD to notice user.

When temp down under 82°C , the controller will again turn on PV input and Load output. Alarm icon disappears.



Low voltage.

Empty battery symbol flashing means the battery is discharged lower than the LVD voltage. The charge Controller has disabled the output. User should charge the battery until it is up to LVR Low voltage re-connect voltage and then BlueSolar Charge Controller will recover the output status.



Short-circuit protection.

This display means a short-circuit protection occurs. The controller will switch off the output and wait for 30s and then try to recover again. User should check and remove the trouble in time.



Over-current protection.

This display means an output over-current occurs. The controller will switch off the output and wait for 30s and then try to recover again. User should check and remove the trouble in time.

Shut down after 60s in case of 110%-130% load.

Shut down after 5s in case of 130%-160% load.



6. Specifications

BlueSolar Charge Controller	12V/24V 30A		48V 10A	48V 20A	48V 30A
Battery Voltage	12/24V Auto Select		48V		
Charge & Load Current	30A		10A	20A	30A
Charge mode	PWM, Time and Lighting Control				
Automatic load disconnect	Yes				
Maximum solar voltage	55V		100V		
Solar voltage range	15-28V	30-55V	60-100V		
Self-consumption	<15mA				
Protections	Reverse polarity connection of the solar panels. Reverse polarity connection of the battery. Low voltage disconnect. 110%-130% load: Shuts down after 60sec. 130%-160% load: Shuts down after 5sec. Short circuit: immediate shut down. Over-temperature protection.				
Solar Panel					
Recommended solar panel array	36cell	72cell	2x72cell in series or 4x36cell in series		
Max Solar Input Power	360W	720W	480W	960W	1440W
USB outputs					
Voltage	5V				
Current	2A (total from 2 USB outputs)				
Default settings					
Absorption charge (b01) ¹	14.4V	28.8V	57.6V		
Float charge (b01) ¹	13.7V	27.4V	54.8V		
Load disconnect (b01) ¹	11.2V	22.4V	44.8V		
Load reconnect (b01) ¹	12.6V	25.2V	50.4V		
Enclosure					
Terminal size	16mm ² / AWG6				
Weight	300gr				
Dimension (h x w x d)	101.50x184.00x47.10 mm				
Mounting	Vertical wall mount Indoor only				
Humidity (non condensing)	Max. 95%				
Operating temperature	-35°C to +60°C (full load)				
Cooling	Natural convection				
Protection class	IP20				
Standards					
Safety	EN60335-1, IEC62109-1				
EMC	EN61000-6-1, EN61000-6-3				

¹ See also 3.1 Battery type setting.



BELANGRIJK

Altijd eerst de accu's aansluiten.

Gebruik voor 12V accusysteem een 12V (36 cellen) zonnepaneelserie.

Gebruik voor 24V accusysteem een 24V (72 cellen) zonnepaneelserie.

Gebruik voor 48V accusysteem een 2x24V (72 cellen) zonnepaneelserie.

1. Algemene Informatie

De BlueSolar Laadregelaar serie maakt gebruik van pulsbreedtemodulatie (PWM) laadspanningsregeling gecombineerd met een meertraps laad regelalgoritme.

2. Kenmerken

- Acculaden in drie fasen [bulk - absorptie - float]
- Accutype: Loodzuur en LiFePO₄ (met interne BMS)
- Beschermd tegen overstroom.
- Beschermd tegen kortsluiting.
- Beschermd tegen omgekeerde polariteitsverbinding van de zonnepanelen en/of accu.
- Ontkoppeling van lage spanning.
- Temperatuurbescherming.

3. Installatie

Belangrijke kennisgeving: altijd eerst de accu's aansluiten.

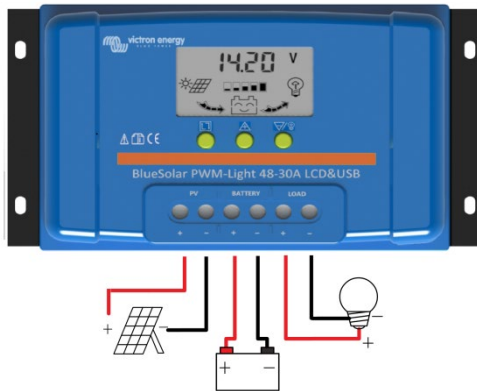

1. Sluit de accu aan op de laadregelaar - plus- en minteken.
2. Sluit de zonnemodus aan op de regelaar - plus- en minteken.
3. Sluit de lading aan op de laadregelaar - plus- en minteken.

De omgekeerde volgorde is van toepassing bij het demonteren.

Een onjuiste volgorde kan de BlueSolar Laadregelaar beschadigen!

1. Controleer of de accu voor de BlueSolar Laadregelaar is opgeladen, om het accutype te herkennen vóór de eerste installatie.
2. De accukabel moet zo kort mogelijk zijn om wegvloeiing te minimaliseren.
3. De BlueSolar Laadregelaar is alleen geschikt voor Loodzuur en LiFePO4 accu's.
4. De BlueSolar Laadregelaar is alleen geschikt voor het regelen van zonnemodules. Nooit een andere laadbron op de lading van de BlueSolar Laadregelaar aansluiten.



victron energy

4. LCD-SCHERM en INSTELLINGEN

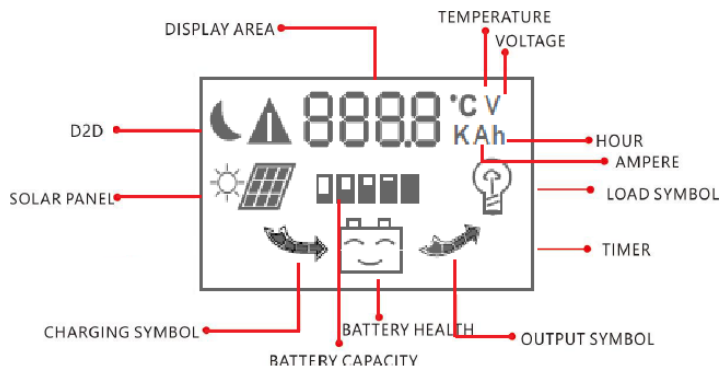

MENU: schakelen tussen verschillende weergaven of om de instelling te openen/sluiten door lang in te drukken.



OMHOOG: indrukken om de instellingen te wijzigen in de instellingsmodus.



OMLAAG: indrukken om de instellingen te wijzigen in de instellingsmodus. Laden aan-/uitknop wanneer in H-modus.

EN

NL

FR

DE

ES

SV

IT

Appendix

4.1 Monitoring en instellingen

Waarden tussen [] zijn voor 24V-accu instellingen. Zwart gedrukt zijn de 48V-instellingen.

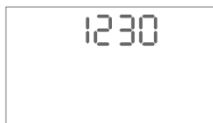

Opstartscherm. Na het aansluiten van de accu's ziet u het type lader en de gemeten accuspanning.

1230 = BlueSolar Laadregelaar - LCD - USB 12V | 30A

2430 = BlueSolar Laadregelaar - LCD - USB 24V | 30A

4810 = BlueSolar Laadregelaar - LCD - USB 48V | 10A

4820 = BlueSolar Laadregelaar - LCD - USB 48V | 20A

4830 = BlueSolar Laadregelaar - LCD - USB 48V | 30A

Druk op MENU  om naar het volgende scherm te gaan.



Hoofdscherm Het geeft de accuspanning, accucapaciteit, laden en ontladen status weer.

Druk op MENU  om naar het volgende scherm te gaan.

Wijzigen van instellingen in het Hoofdscherm. Druk gedurende enkele seconden op de MENU  toets, totdat de cijfers knipperen, u bevindt zich in:



Instelling accutype.
Zie onderstaande tabel.

De fabrieksinstelling is b01

	Accutype	Accuspanning	Absorptie vermogen	Float-lading	Fabrieksinstelling voor ontkoppeling bij laagspanning	Laagspanning bereik ontkoppelen	Fabrieksinstelling voor ontkoppeling verbinden op laagspanning	Laagspanning bereikt opnieuw koppelen
b01	LOODZUUR R [AGM]	12,0V [24V] 48V	14,4V [28,8V] 57,6V	13,7V [27,4V] 54,8V	11,2V [22,4V] 44,8V	10,5V-12,0V in stappen van 0,1V	12,6V [25,2V] 50,4V	12,0V-13,5V in stappen van 0,1V
b02	LOODZUUR R [Gel]	12,0V [24V] 48V	14,2V [28,4V] 56,8V	13,7V [27,4V] 54,8V	11,2V [22,4V] 44,8V	10,5V-12,0V in stappen van 0,1V	12,6V [25,2V] 50,4V	12,0V-13,5V in stappen van 0,1V
b03	LOODZUUR R [Wet]	12,0V [24V] 48V	14,6V [29,2V] 58,4V	13,7V [27,4V] 54,8V	11,2V [22,4V] 44,8V	10,5V-12,0V in stappen van 0,1V	12,6V [25,2V] 50,4V	12,0V-13,5V in stappen van 0,1V
b04*	12V LiFePO4	12.8V	14.2V	13.35V	11.2V	10.5V-12.0V in stappen van 0.1V	12.6V	12.0V-13.5V in stappen van 0.1V
b05*	24V LiFePO4	25.6V	28.4V	26.7V	22.4V	21.0V-24.0V in stappen van 0.1V	25.2V	24.0V-27.0V in stappen van 0.1V

*De regelaars hebben geen externe aan/uit-ingang. Gebruik daarom LiFePO4-batterijen met alleen geïntegreerd BMS (zoals de Victron SuperPack-batterijen)

*NA voor 48V



victron energy

Druk op het MENU  toets opnieuw en u bevindt zich in:



Laagspanning ontkoppelen
De fabrieksinstelling is 11,2V [22,4V] **44,8V**

Druk op het MENU  toets opnieuw en u bevindt zich in:



Laagspanning opnieuw aansluiten
De fabrieksinstelling is 12,6V [25,2V] **50,4V**



Solar Spanningsdisplay. Het geeft de spanning van het Zonnepaneel, de status van de accucapaciteit aan.

Druk op MENU  om naar het volgende scherm te gaan.





Laadstroomdisplay. Het geeft zonne-energie voor de accustroom en laadstatus aan.

Druk op MENU  om naar het volgende scherm te gaan.



Laad werkmodus.
De fabrieksinstelling is 24H

Druk op MENU  om naar het volgende scherm te gaan.

Wijzig de Instellingen in de weergave Werkmodus laden. Druk gedurende enkele seconden op de MENU  toets totdat de cijfers knipperen, u bevindt zich in de instellingsmodus:



Laad werkmodus-instelling.
Zie onderstaande tabel.

EN

NL

FR

DE

ES

SV

IT

Appendix

H	De lading kan worden in- en uitgeschakeld  door de Laad aan- /uitschakelaar..
L	Laad D2D Het laden schakelt in bij zonsondergang en schakelt uit bij zonsopgang.
L01-L23	De laaduitgang wordt na zonsondergang ingeschakeld en schakelt na 1-23 uur uit.
24H	De BlueSolar Laadregelaar levert continu stroom aan uw lading.

Druk nogmaals op het MENU  toets en u gaat naar:
(Opmerking: de Phoenix VE.Direct-omvormers kunnen worden bediend door verbinding te maken met de linkerkant van de afstandsbediening met de belastingsuitgang)



Laadinstelling:

activeringswaarde (zonnepaneelspanning)
Wanneer de werkmodus L01-L23 is, meet de laadregelaar de spanning van het zonnepaneel om te beslissen of het overdag of 's nachts de lading in- of uitschakelt. Hoe hoger deze waarde, hoe eerder deze de laaduitgang inschakelt.
De fabrieksinstelling is 4/8/16V

Druk nogmaals op het MENU  toets en u gaat naar:



L01-L23 activering

vertragswaarde (seconden)
Wanneer de laadregelaar een spanning van het zonnepaneel meet die lager is dan deze waarde, wordt deze 10 seconden vertraagd en opnieuw gemeten om te zorgen dat het 's nachts inschakelt.
De fabrieksinstelling is 10sec

Druk nogmaals op het MENU  toets en u gaat naar:



Kortsluitbeveiligingsinstelling

Sommige inductieve of capacitieve consumptie activeren de kortsluitbeveiliging tijdens het opstarten. Daarom kunt u de SC-beveiliging handmatig uitschakelen.
Sc.F=UIT, Sc.n=AAN. De standaardinstelling is INGESCHAKELD.
De fabrieksinstelling is Sc.n.



Laad huidige display: Het geeft de laadstroom en de accucapaciteit aan.

Druk op MENU  om naar het volgende scherm te gaan.



USB-spanningsdisplay: Het geeft de USB-spanning aan
5V
2A max

Druk op MENU  om naar het volgende scherm te gaan.



Temperatuurweergave van de besturingseenheid Indien de besturingseenheid heet wordt terwijl hij is ingeschakeld, wordt deze automatisch uitgeschakeld en wacht tot de temperatuur weer is gedaald tot het normale niveau en zal opnieuw starten.

Druk op MENU  om het Hoofdscherm te openen.

EN

NL

FR

DE

ES

SV

IT

Appendix

5. Alarmen

Hoge temperatuur

Temp <85 °C, besturingseenheid werkt normaal.

Wanneer temp ≥ 85 °C, zal de besturingseenheid de eerste beschermingsfase activeren:

1. De besturingseenheid zal de PV-ingangsstroom verlagen om de regeltemperatuur te verlagen; maar Laden werkt normaal. Er wordt geen alarm op het LCD-scherm weergegeven.

Wanneer temp > 90 °C is, zal de besturingseenheid de tweede beschermingsfase activeren:

2. De besturingseenheid zal de PV-ingangsstroom onderbreken. Laaduitgang uitschakelen. Een pictogram voor een hoog temperatuuralarm verschijnt op het LCD-scherm om de gebruiker op te waarschuwen.

Wanneer de temperatuur lager is dan 82 °C, schakelt de besturingseenheid opnieuw de PV-ingang en de Laaduitgang in. Alarmpictogram verdwijnt.



Laagspanning.

Symbool voor lege accu knippert, de accu is lager dan de LVD-spanning ontladen. De BlueSolar Laadregelaar heeft de uitgang uitgeschakeld. De gebruiker moet de accu opladen totdat de LVR opnieuw spanning laadt en de BlueSolar Laadregelaar zal de uitvoerstatus herstellen.



Kortsluitingsbeveiliging.

Dit scherm betekent dat er een beveiliging tegen kortsluiting optreedt. De laadregelaar schakelt de uitgang uit, wacht 30 seconden en probeert vervolgens te herstarten. De gebruiker zou de problemen op tijd moeten controleren en verwijderen.



Overstroombeveiliging.

Dit scherm betekent dat er een uitgang overstroom optreedt. De laadregelaar schakelt de uitgang uit, wacht 30 seconden en probeer vervolgens herstarten. De gebruiker zou de problemen op tijd moeten controleren en verwijderen. Uitschakelen na 60s bij 110% -130% lading. Uitschakelen na 5 seconden bij 130% tot 160% lading.



victron energy

6. Specificaties

BlueSolar Laadregelaar	12V/24V 30A		48V 10A	48V 20A	48V 30A
Accuspanning	12/24V Auto Selecteer		48V		
Laden & Laadstroom	30A		10A	20A	30A
Laadmodus	PWM, Tijd- en Lichtregeling				
Automatische laadafsluiting	Ja				
Maximale zonnepanning	55V		100V		
Zonnepanningsbereik	15-28V	30-55V	60-100V		
Eigen verbruik	<15mA				
Beveiligingen	Omgekeerde polariteitsverbinding van de zonnepanelen. Omgekeerde polariteitsverbinding van de accu. Ontkoppeling met lage spanning. 110%-130% lading: Schakelt uit na 60 sec. 130%-160% lading: Schakelt uit na 5 seconden. Kortsluiting: onmiddellijk uitgeschakeld. Overtemperatuurbeveiliging.				
Zonnepaneel					
Aanbevolen zonnepaneelserie	36 cellen	72 cellen	2x72 cellen in serie of 4x36 cellen in serie		
Max. ingangsvermogen voor zonne-	360W	720W	480W	960W	1440W
USB-uitgangen					
Spanning	5V				
Spanning	2A (totaal van 2 USB-uitgangen)				
Standaard instellingen					
Absorptie-lading (b01) ¹	14,4V	28,8V	57,6V		
Float-lading (b01) ¹	13,7V	27,4V	54,8V		
Ontkoppel de belasting (b01) ¹	11,2V	22,4V	44,8V		
Lading opnieuw verbinden (b01) ¹	12,6V	25,2V	50,4V		
Behuizing					
Terminal grootte	16mm ² / AWG6				
Gewicht	300g				
Afmetingen (h x b x d)	101,50x184,00x47,10 mm				
Montage	Verticale wandmontage, alleen binnenshuis				
Vochtigheid (zonder condensatie)	Max. 95%				
Bedrijfstemperatuur	-35 °C tot + 60 °C (volledige lading)				
Koeling	Natuurlijke convectie				
Beschermingsklasse	IP20				
Normen					
Veiligheid	EN60335-1, IEC62109-1				
EMC	EN61000-6-1, EN61000-6-3				

¹ Zie ook 3.1 Instelling accutype.

EN

NL

FR

DE

ES

SV

IT

Appendix



IMPORTANT

Toujours connecter les batteries en premier.

Pour un système de batterie de 12 V, n'utilisez que le dispositif de panneaux solaires de 12 V (36 cellules).

Pour un système de batterie de 24 V, n'utilisez que le dispositif de panneaux solaires de 24 V (72 cellules).

Pour un système de batteries de 48 V, n'utilisez que le dispositif de panneaux solaires de 2x24 V (72 cellules).

1. Consignes générales

La gamme de contrôleurs de charge BlueSolar utilise le contrôle de tension de charge « Pulse Width Modulation » (PWM - Modulation de largeur d'impulsions) allié à un algorithme de contrôle de charge en plusieurs étapes.

2. Fonctions

- Trois étapes de charge de batterie (Bulk – absorption – Float).
- Type de batterie : au plomb et LiFePO4 (avec BMS interne)
- Protection contre la surintensité.
- Protection contre les courts-circuits.
- Protection contre la connexion en polarité inversée des panneaux solaires et/ou de la batterie
- Déconnexion de la charge en cas de tension réduite.
- Protection relative à la température.

3. Installation

Remarque importante : toujours connecter les batteries en premier.



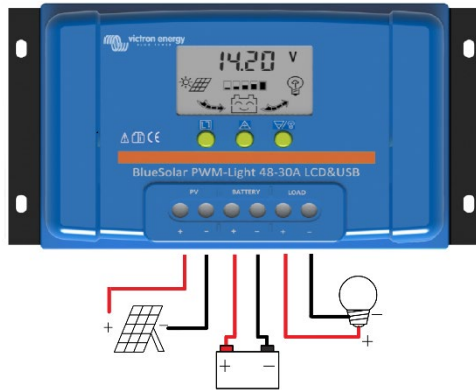

1. Connectez la batterie au régulateur de charge – pôle positif et négatif.
2. Connectez le module solaire au régulateur – pôle positif et négatif.
3. Connectez la charge consommatrice au régulateur de charge – pôle positif et négatif.

**Pour désinstaller, veuillez suivre les étapes en sens inverse.
Inverser l'ordre de la séquence peut endommager le contrôleur de charge BlueSolar !**

1. Assurez-vous que votre batterie est chargée afin que le contrôleur de charge BlueSolar reconnaisse le type de batterie avant la première installation.
2. Le câble de batterie doit être le plus court possible pour réduire les pertes.
3. Le contrôleur de chargeur n'est adapté que pour des batteries au plomb et LiFePO4.
4. Le contrôleur de charge BlueSolar n'est adapté que pour régler des modules solaires.
Ne jamais connecter une autre source de charge au contrôleur de charge BlueSolar.

4. ÉCRAN LCD et PARAMÈTRES

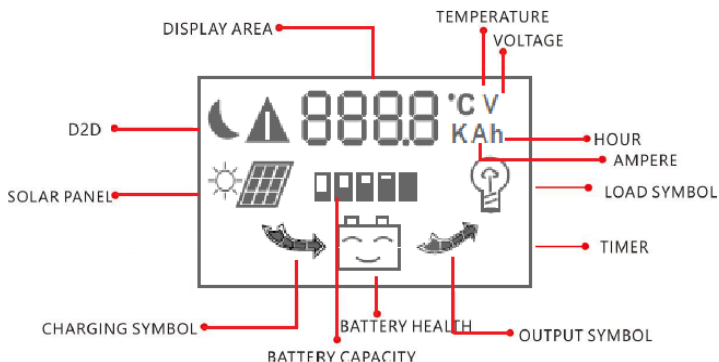

MENU : pour passer d'un écran à l'autre ou pour entrer/quitter la configuration en maintenant le bouton appuyé.



UP : appuyez pour modifier les paramètres lorsque vous êtes en mode Configuration.



DOWN : appuyez pour modifier les paramètres lorsque vous êtes en mode Configuration.

Bouton de démarrage/arrêt de charge en mode H.

4.1 Supervision et paramètres

Les valeurs entre [] correspondent à des paramètres de batterie de 24 V.

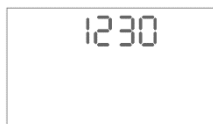

Initialiser l'écran. Après avoir connecter les batteries, le type de chargeur et la tension de batterie mesurée s'afficheront.

1230=Contrôleur de charge BlueSolar – LCD – USB 12 V|30 A

2430=Contrôleur de charge BlueSolar – LCD – USB 24 V|30 A

4810=Contrôleur de charge BlueSolar – LCD – USB 48 V|10 A

4820=Contrôleur de charge BlueSolar – LCD – USB 48 V|20 A

4830=Contrôleur de charge BlueSolar – LCD – USB 48 V|30 A

Appuyez sur MENU  pour passer à l'écran suivant.



Écran principal. Il indique la tension de la batterie, sa capacité et le statut de son processus de charge et décharge.

Appuyez sur MENU  pour passer à l'écran suivant.

Modifier les paramètres sur l'écran principal.

Appuyez sur le bouton MENU  pendant plusieurs secondes jusqu'à ce que le nombre clignote, vous arrivez dans :



Configuration du type de batterie.

Voir le tableau ci-dessous.

Le réglage standard est b01.

	Type de batterie	Tension de la batterie	Tension d'absorption	Tension Float	Tension faible Configuration d'usine pour la déconnexion	Tension faible Plage de déconnexion	Tension faible Configuration d'usine pour la reconnexion	Plage de reconnexion en cas de tension faible
b01	PLOMB [AGM]	12,0 V [24 V] 48 V	14,4 V [28,8 V] 57,6 V	13,7 V [27,4 V] 54,8 V	11,2 V [22,4 V] 44,8 V	10,5 V-12,0 V par étapes de 0,1 V	12,6 V [25,2 V] 50,4 V	12,0 V-13,5 V par étapes de 0,1 V
b02	PLOMB [À électrolyte gélifié]	12,0 V [24 V] 48 V	14,2 V [28,4 V] 56,8 V	13,7 V [27,4 V] 54,8 V	11,2 V [22,4 V] 44,8 V	10,5 V-12,0 V par étapes de 0,1 V	12,6 V [25,2 V] 50,4 V	12,0 V-13,5 V par étapes de 0,1 V
b03	PLOMB [À électrolyte]	12,0 V [24 V] 48 V	14,6 V [29,2 V] 58,4 V	13,7 V [27,4 V] 54,8 V	11,2 V [22,4 V] 44,8 V	10,5 V-12,0 V par étapes de 0,1 V	12,6 V [25,2 V] 50,4 V	12,0 V-13,5 V par étapes de 0,1 V
b04*	12V LiFePO4	12.8V	14.2V	13.35V	11.2V	10.5V-12.0V par étapes de 0.1V	12.6V	12.0V-13.5V par étapes de 0.1V
b05*	24V LiFePO4	25.6V	28.4V	26.7V	22.4V	21.0V-24.0V par étapes de 0.1V	25.2V	24.0V-27.0V par étapes de 0.1V

*Les contrôleurs ne disposent pas d'une entrée d'allumage/arrêt à distance. C'est pourquoi, il ne faut utiliser que des batteries LiFePO4 avec un BMS intégré (telles que les batteries SuperPack Victron).

ND pour 48 V

Appuyez à nouveau sur la touche MENU  pour arriver dans :



Déconnexion en cas de tension réduite :

Le réglage standard est 11,2 V [22,4 V] **44,8 V**

Appuyez à nouveau sur la touche MENU  pour arriver dans :



Reconnexion en cas de tension faible

Le réglage standard est 12,6 V [25,2 V] **50,4 V**

EN

NL

FR

DE

ES

SE

IT

Appendix



Écran de tension solaire. Il affiche la tension des panneaux solaires, le statut de la capacité de la batterie.

Appuyez sur MENU pour passer à l'écran suivant.



Écran de courant de charge. Il indique le courant qui va de la batterie au champ solaire et le statut du processus de charge.

Appuyez sur MENU pour passer à l'écran suivant.



Mode Charge au travail.

Le réglage standard est 24 h.

Appuyez sur MENU pour passer à l'écran suivant.

Modifiez les paramètres sur l'écran du mode Charge consommatrice au travail.

Appuyez sur le bouton MENU pendant plusieurs secondes jusqu'à ce que le nombre clignote, vous êtes :



Configuration du Mode Charge consommatrice au travail.

Voir le tableau ci-dessous.

H	Le chargeur de batterie peut être allumé et éteint avec l'interrupteur d'allumage/arrêt.
L	Charge D2D La charge consommatrice s'allumera au coucher du soleil et s'éteindra au lever du soleil.
L01-L23	La sortie de la charge consommatrice s'allumera après le coucher du soleil et s'éteindra après 1-23 heures.
24H	Le contrôleur de charge BlueSolar alimentera votre charge consommatrice en continu.

Appuyez à nouveau sur la touche MENU pour vous diriger vers : **(Remarque : les convertisseurs Phoenix VE.Direct peuvent être contrôlés en raccordant la connexion de gauche au contrôle à distance de la sortie de la charge).**



Configuration de la charge consommatrice : valeur de déclenchement (tension des panneaux solaires)
Lorsque le mode de fonctionnement est L01-L23, le contrôleur de charge BlueSolar mesurera la tension des panneaux solaires pour décider s'il fait jour ou s'il fait nuit, et ainsi allumer ou éteindre la charge consommatrice. Plus la

Appuyez à nouveau sur la touche MENU  pour vous diriger vers :



valeur est élevée, plus tôt il allumera la sortie de la charge. Le réglage standard est 4/8/16 V

Valeur du temps de retard de déclenchement L01-L23 (secondes)

Lorsque le contrôleur de charge mesure une tension sur les panneaux solaires inférieure à cette valeur de déclenchement, il attendra 10 secondes et mesurera à nouveau pour s'assurer que la nuit tombe. Le réglage standard est 10 s.

Appuyez à nouveau sur la touche MENU  pour vous diriger vers :



Configuration de la protection contre les courts-circuits.

Certains appareils de consommation inductifs ou capacitifs déclencheront la protection contre les courts-circuits au démarrage. Cependant, vous pouvez désactiver la protection contre les courts-circuits (SC) manuellement. Sc.F=OFF, Sc.n=ON. Par défaut, le paramètre standard est sur ON. Le réglage standard est Sc.n.



Écran du courant de la charge consommatrice. Il affiche le courant de la charge et la capacité de batterie.

Appuyez sur MENU  pour passer à l'écran suivant.



Écran de tension USB. Il affiche la tension USB. **5 V**

2 A max
Appuyez sur MENU  pour passer à l'écran suivant.



Écran de température du contrôleur. Si le contrôleur chauffe durant son fonctionnement, il s'éteindra automatiquement et il attendra que la température baisse à un niveau normal avant de recommencer à fonctionner. Appuyez sur MENU  pour passer à l'écran principal.

5. Alarmes

Température élevée

Temp. <85°C, le contrôleur travaille normalement.

Si la temp. est $\leq 85^\circ\text{C}$, le contrôleur adoptera la première phase de protection :

1. le contrôleur réduira le courant d'entrée PV afin de baisser la température du contrôleur, mais la charge consommatrice travaillera normalement. Aucune alarme n'apparaît sur l'écran LCD.

Si la temp. est $\leq 90^\circ\text{C}$, le contrôleur adoptera la seconde phase de protection :

2. Le contrôleur coupera le courant d'entrée PV. Coupure de la sortie de la charge. Une icône d'alarme de température élevée s'affichera sur l'écran LCD pour avertir l'utilisateur.

Lorsque la température passe en dessous de 82°C , le contrôleur allumera à nouveau l'entrée PV et la sortie de la charge. L'icône de l'alarme disparaîtra.



Tension faible.

Si le symbole de batterie vide clignote, cela signifie que la batterie est déchargée en dessous de la tension LVD. Le contrôleur de charge BlueSolar a désactivé la sortie. L'utilisateur devra charger la batterie jusqu'à ce qu'elle atteigne la tension LVR de Reconnexion en cas de tension faible, puis le contrôleur de charge BlueSolar récupérera le statut de la sortie.



Protection contre les courts-circuits.

Cet écran signifie qu'une protection contre les courts-circuits s'est déclenchée. Le contrôleur de charge BlueSolar éteindra la sortie et attendra pendant 30 secondes, puis il essaiera de redémarrer à nouveau. L'utilisateur devra vérifier et résoudre la panne à temps.



Protection contre la surintensité.

Cet écran signifie qu'une condition de surintensité se produit. Le contrôleur de charge BlueSolar éteindra la sortie et attendra pendant 30 secondes, puis il essaiera de redémarrer à nouveau. L'utilisateur devra vérifier et résoudre la panne à temps. Arrêt au bout de 60 s en cas de charge à 110-130 %. Arrêt au bout de 5 s en cas de charge à 130-160 %.



6. Caractéristiques

Contrôleur de charge BlueSolar	12 V 24 V 30 A		48 V 10 A	48 V 20 A	48 V 30 A
Tension de batterie	Sélection automatique 12/24 V		48 V		
Charge et courant de la charge	30 A		10 A	20 A	30 A
Mode de charge	PWM, Contrôle de l'éclairage et du temps				
Déconnexion automatique de la charge	Oui				
Tension solaire maximale	55 V		100 V		
Plage de tension solaire	15-28 V	30-55 V	60-100 V		
Autoconsommation	< 15 mA				
Protections	Connexion en polarité inversé des panneaux solaires. Connexion en polarité inversé de la batterie. Déconnexion en cas de tension réduite. Charge à 110 % — 130 % : arrêt au bout de 60 s. Charge à 130 % — 160 % : arrêt au bout de 5 s. Court-circuit : arrêt immédiat. Protection contre la surchauffe.				
Panneau solaire					
Champ de panneaux solaires recommandé	36 cellules	72 cellules	2x72 cellules en série ou 4x36 cellules en série		
Puissance d'entrée solaire max.	360 W	720 W	480 W	960 W	1440 W
Sorties USB					
Tension	5 V				
Courant	2 A (total depuis 2 sorties USB)				
Paramètres par défaut					
Charge d'absorption (b01) ¹	14,4 V	28,8 V	57,6 V		
Charge Float (b01) ¹	13,7 V	27,4 V	54,8 V		
Déconnexion de charge (b01) ¹	11,2 V	22,4 V	44,8 V		
Reconnexion de charge (b01) ¹	12,6 V	25,2 V	50,4 V		
Boîtier					
Taille de la borne	16 mm ² / AWG6				
Poids	300 g				
Dimension (h x l x p)	101,50 x 184,00 x 47,10 mm				
Montage	Montage au mur vertical / Seulement à l'intérieur				
Humidité (sans condensation)	Max. 95 %				
Température d'exploitation	-35°C à +60 °C (charge pleine)				
Refroidissement	Convection naturelle				
Classe de protection	IP20				
Normes					
Sécurité	EN60335-1, IEC62109-1				
EMC	EN61000-6-1, EN61000-6-3				

¹ Voir également la section 3.1 Configuration du type de batterie.

WICHTIGER HINWEIS

Schließen Sie immer zuerst die Batterien an.

Verwenden Sie für 12 V Batterie-Systeme nur 12 V (36 Zellen) Solarmodulanlagen.

Verwenden Sie für 24 V Batterie-Systeme nur 24 V (72 Zellen) Solarmodulanlagen.

Verwenden Sie für 48 V Batterie-Systeme nur 2x24 V (72 Zellen) Solarmodulanlagen in Reihe.

1. Allgemeine Informationen

Die Serie der BlueSolar Lade-Regler verwendet zur Ladespannungsregelung eine Pulsweitenmodulation (PWM) kombiniert mit einem mehrstufigen Lade-Regel-Algorithmus.

2. Funktionen

- Ladung der Batterie in drei Stufen [Konstantstrom, Konstantspannung, Ladeerhaltung].
- Batterietyp: Blei-SÄURE und LiFePO4 (mit integriertem BMS)
- Schutz vor Überstrom.
- Kurzschluss-Schutz.
- Verpolungsschutz für Solarmodule und/oder Batterie.
- Abschalten der Last bei geringer Spannung.
- Temperaturschutz.

3. Installation

Wichtiger Hinweis: Schließen Sie immer zuerst die Batterien



1. Schließen Sie die Batterie an den Lade-Regler an - Plus und Minus
2. Schließen Sie das Solarmodul an den Lade-Regler an - Plus und Minus
3. Schließen Sie die Last an den Lade-Regler an - Plus und Minus

Beim Deinstallieren umgekehrt vorgehen.

Bei Nichteinhaltung der richtigen Abfolge kann der BlueSolar Lade-Regler beschädigt werden.

1. Achten Sie darauf, dass Ihre Batterie vor der Erstinstallation geladen ist, damit der BlueSolar Lade-Regler den Batterietyp erkennen kann.
2. Das Batteriekabel sollte so kurz wie möglich sein, um Kabelverluste zu minimieren.
3. Das Gerät ist nur für Blei-Säure und LiFePO4-Batterien geeignet.
4. Der BlueSolar Lade-Regler ist nur zur Regelung von Solarmodulen geeignet. Schließen Sie nie eine andere Ladequelle an den BlueSolar Lade-Regler an.

4. LCD- Display und Einstellungen

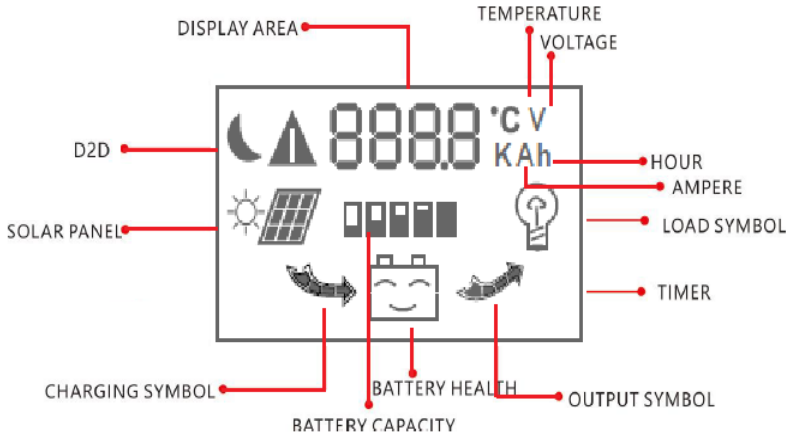

MENÜ : Zwischen verschiedenen Anzeigen hin- und herschalten oder Aufrufen/Verlassen der Einstellungen durch anhaltendes Drücken.



HOCH: im Einstellungsmodus lassen sich damit die Einstellungen ändern.



RUNTER: im Einstellungsmodus lassen sich damit die Einstellungen ändern.
Taste Last ein/aus im H-Modus

4.1 Überwachung und Einstellungen

Die Werte zwischen [] sind für 24 V-Batterieeinstellungen. **Fett Gedrucktes** bezieht sich auf die 48 V Einstellungen.

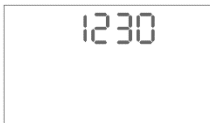

Start-Bildschirm Nach dem Anschließen der Batterien werden der Ladegerätetyp und die gemessene Batteriespannung angezeigt.

1230= BlueSolar Lade-Regler – LCD – USB 12 V|30 A

2430= BlueSolar Lade-Regler – LCD – USB 24 V|30 A

4810= BlueSolar Lade-Regler – LCD – USB 48 V|10 A

4820= BlueSolar Lade-Regler – LCD – USB 48 V|20 A

4830= BlueSolar Lade-Regler – LCD – USB 48 V|30 A

Durch Betätigen der Taste MENU  gelangen Sie zum nächsten Bildschirm.



Hauptanzeigebildschirm

Es wird die Batteriespannung, die Batteriekapazität, der Lade- und Entladestatus angezeigt.

Durch Betätigen der Taste MENU  gelangen Sie zum nächsten Bildschirm.



Einstellung des Batterietyps
Siehe Tabelle unten.

Die Werkseinstellung ist b01.

Änderung der Einstellungen im Hauptanzeigebildschirm
Halten Sie die Taste MENU  einige Sekunden lang gedrückt, bis die Zahlen, bei denen Sie sich gerade befinden, zu blinken beginnen:

	Batterietyp	Battery voltage (Batteriespannung):	Absorption voltage (Konstantspannung)	Float voltage (Erhaltungsspannung)	Low voltage (Niedrige Spannung) Werkseinstellungen für Abschaltbefehl	Low voltage (Niedrige Spannung) Bereich zum Abschalten	Low voltage (Niedrige Spannung) Werkseinstellungen für Befehl zum erneuten Einschalten	Bereich zum erneuten Einschalten nach niedriger Spannung
b01	BLEI-SÄURE [AGM]	12,0 V – 24 V 48 V	14,4 V – 28,8 V 57,6 V	13,7 V – [27,4 V] 54,8 V	11,2V – [22,4V] 44,8 V	10,5 V-12,0 V in Schritten von 0,1 V	12,6 V – [25,2 V] 50,4 V	12,0 V-13,5 V in Schritten von 0,1 V
b02	BLEI-SÄURE [Gel]	12,0 V – [24 V] 48 V	14,2 V – 28,4 V 56,8V	13,7 V – [27,4 V] 54,8 V	11,2 V – [22,4 V] 44,8 V	10,5 V-12,0 V in Schritten von 0,1 V	12,6 V – [25,2 V] 50,4 V	12,0 V-13,5 V in Schritten von 0,1 V
b03	BLEI-SÄURE [Nass]	12,0 V – [24 V] 48 V	14,6 V – [29,2 V] 58,4 V	13,7 V – [27,4 V] 54,8 V	11,2 V – [22,4 V] 44,8 V	10,5 V-12,0 V in Schritten von 0,1 V	12,6 V – [25,2 V] 50,4 V	12,0 V-13,5 V in Schritten von 0,1 V
b04*	12V LiFePO4	12.8V	14.2V	13.35V	11.2V	10.5V-12.0V in schritten von 0.1V	12.6V	12.0V-13.5V in schritten von 0.1V
b05*	24V LiFePO4	25.6V	28.4V	26.7V	22.4V	21.0V-24.0V in schritten von 0.1V	25.2V	24.0V-27.0V in schritten von 0.1V

*Die Regler verfügen nicht über einen ferngesteuerten Ein-/Ausgang. Daher dürfen nur LiFePO4 Batterien mit eingebautem BMS verwendet werden (z. B. Victron SuperPack Batterien) NA für 48V *NA für 48V

Bei erneutem Betätigen der Taste MENU  gelangen Sie zu folgenden Einstellungen:



Spannung niedrig- abschalten (LVD)
Die Werkseinstellung ist 11,2 V [22,4 V] **44,8 V**

Bei erneutem Betätigen der Taste MENU  gelangen Sie zu folgenden Einstellungen:



Erneutes Verbinden nach niedriger Spannung (LVR)
Die Werkseinstellung ist 12,6 V [25,2 V] **50,4 V**



Anzeigebildschirm Solarspannung

Hier wird die Spannung der Solarmodule und der Status der Batteriekapazität angezeigt.

Durch Betätigen der Taste MENU  gelangen Sie zum nächsten Bildschirm.



Anzeigebildschirm Ladestrom

Hier wird der Solar- zu Batteriestrom und der Ladezustand angezeigt.



Durch Betätigen der Taste MENU  gelangen Sie zum nächsten Bildschirm.

Last-Betriebs-Modus:

Die Werkseinstellung ist 24 h.

Durch Betätigen der Taste MENU  gelangen Sie zum nächsten Bildschirm.

Änderung der Einstellungen im Last-Betriebs-Modus-Anzeigebildschirm. Halten Sie die Taste MENU  einige Sekunden lang gedrückt, bis die Zahlen zu blinken beginnen. Sie befinden sich dann im Einstellungsmodus für die:



Last-Betriebs-Modus-Einstellung.

Siehe Tabelle unten.

H	Die Last kann durch den  Last ein/aus Schalter ein- und ausgeschaltet werden.
L	Last D2D Die Last wird bei Sonnenuntergang ein- und bei Sonnenaufgang ausgeschaltet.
L01-L23	Die Last wird nach Sonnenuntergang eingeschaltet und nach 1-23 Stunden ausgeschaltet.
24 H	Der BlueSolar Lade-Regler versorgt die Last ständig mit Energie.

Bei erneutem Betätigen der Taste MENU  gelangen Sie zu folgenden Einstellungen:
(Hinweis: Phoenix VE.Direct Wechselrichter lassen sich steuern, indem sie an die linke Seite der Fernsteuerung am Lastausgang



Last-Einstellung: Auslösewert
(Solar-Modul-Spannung)

Ist der Betriebsmodus L01-L23, misst der Lade-Regler die Spannung der Solarmodule, um zu entscheiden, ob es gerade Tag oder Nacht ist und ob die Last ein- oder ausgeschaltet werden soll. Je höher dieser Wert ist, desto früher schaltet er den Lastausgang ein. Die Werkseinstellung ist 4/8/16 V

angeschlossen werden.)

Bei erneutem Betätigen der Taste MENU  gelangen Sie zu folgenden Einstellungen:



L01-L23 Auslösewert

Verzögerung (Sekunden)

Misst der Lade-Regler einen Spannungswert eines Solarmoduls unterhalb dieses Wertes, wartet er 10 s lang und misst erneut, um sicherzugehen, dass die Nacht anbricht.

Die Werkseinstellung ist 10 s.

Bei erneutem Betätigen der Taste MENU  gelangen Sie zu folgenden Einstellungen:



Einstellungen Kurzschluss-Schutz

Einige induktive oder kapazitive Verbraucher lösen beim Einschalten den Kurzschluss-Schutz aus. Aus diesem Grund lässt sich der Kurzschluss-Schutz (SC) manuell deaktivieren. Sc.F=AUS, Sc.n=AN. Standardeinstellung ist EIN. Die Werkseinstellung ist Sc.n.

Anzeigebildschirm Laststrom Hier werden Last-Strom und Batteriekapazität angezeigt.



Durch Betätigen der Taste MENU  gelangen Sie zum nächsten Bildschirm.

Anzeigebildschirm USB-Spannung Hier wird die USB-Spannung angezeigt.



**5 V
2 A max.**

Durch Betätigen der Taste MENU  gelangen Sie zum nächsten Bildschirm.

Anzeigebildschirm Temperatur des Reglers Wird der Regler beim Betrieb heiß, schaltet er sich automatisch ab und wartet, bis er auf Normaltemperatur heruntergekühlt ist. Dann nimmt er den Betrieb wieder auf.



Durch Betätigen der Taste MENU  gelangen Sie zum Haupt-Bildschirm.

5. Alarme

EN

NL

FR

DE

ES

SE

IT

Appendix

Hohe Temperatur

Temperatur $<85^{\circ}\text{C}$, Regler arbeitet normal.

Wenn die Temperatur $\geq 85^{\circ}\text{C}$, schaltet der Regler in die erste Schutzphase:

1. Er verringert den PV-Eingangsstrom, um seine Temperatur zu senken. Die Last arbeitet dabei jedoch normal. Es erscheint keine Anzeige auf dem LCD-Display.

Wenn die Temperatur $>90^{\circ}\text{C}$, schaltet der Regler in die zweite Schutzphase:

1. Der Regler schaltet den PV-Eingangsstrom ab. Abschalten des Lastausgangs. Auf dem LCD-Bildschirm erscheint ein Alarm-Symbol und informiert den Nutzer über die zu hohe Temperatur.

Wenn die Temperatur wieder unter 82°C abfällt, schaltet der Regler den PV-Eingang und den Last-Ausgang wieder ein. Das Alarm-Symbol wird dann nicht mehr angezeigt.



Niedrige Spannung

Wenn das Symbol für "Batterie leer" blinkt, bedeutet das, dass die Batterie bis auf unter den Spannungswert zum Abschalten aufgrund niedriger Spannung (LVD) entladen ist. Der BlueSolar Lade-Regler hat den Ausgang abgeschaltet. Der Nutzer sollte die Batterie solange laden, bis sie die Spannungsschwelle zum erneuten Anschließen nach niedriger Spannung (LVR) erreicht hat. Der BlueSolar Lade-Regler nimmt dann die Arbeit am Ausgang wieder auf.



Kurzschluss-Schutz

Diese Anzeige bedeutet, dass sich der Kurzschluss-Schutz eingeschaltet hat. Der BlueSolar Lade-Regler schaltet den Ausgang aus und wartet 30 Sekunden lang, bevor er versucht, neu zu starten. Der Nutzer sollte die Ursache überprüfen und rechtzeitig beheben.



Überstrom-Schutz

Dieser Anzeigebildschirm bedeutet, dass ein Über-Strom aufgetreten ist. Der BlueSolar Lade-Regler schaltet den Ausgang aus und wartet 30 Sekunden lang, bevor er versucht, neu zu starten. Der Nutzer sollte die Ursache überprüfen und rechtzeitig beheben.

Abschalten nach 60 s bei einer Last von 110 %-130 %
Abschalten nach 5 s bei einer Last von -130 %-160 %



6. Technische Daten

BlueSolar Lade-Regler	12 V/24 V 30 A		48 V 10 A	48 V 20 A	48 V 30 A
Batteriespannung	12/24 V automatische Wahl		48 V		
Lade- & Last-Strom	30 A		10 A	20 A	30 A
Lade-Modus	PWM, Zeit- und Beleuchtungsregelung				
Automatische Lastabschaltung	Ja				
Maximale Solar-Spannung	55 V		100 V		
Solarspannungsbereich	15-28 V	30-55 V	60-100 V		
Eigenverbrauch	<15 mA				
Schutz	Verpoltter Anschluss der Solarmodule Verpoltter Anschluss der Batterie Niedrige Spannung - abschalten (LVD) 110 %-130 % Last: Schaltet nach 60 s ab. 130 %-160 % Last: Schaltet nach 5 s ab. Kurzschluss: sofortiges Abschalten Überhitzungsschutz				
Solarmodul					
Empfohlene Solarmodul-Anlage	36 Zellen	72 Zellen	2x72 Zellen in Reihe oder 4x36 Zellen in Reihe		
Max. Solar-Eingangsleistung	360 W	720 W	480 W	960 W	1440 W
USB-Ausgänge					
Spannung	5 V				
Strom	2 A (gesamt von 2 USB-Ausgängen)				
Standardeinstellungen					
Konstantspannungsphase (b01) ¹	14,4 V	28,8 V	57,6 V		
Erhaltungsladungsphase (b01) ¹	13,7 V	27,4 V	54,8 V		
Last abschalten (b01) ¹	11,2 V	22,4 V	44,8 V		
Last wieder einschalten (b01) ¹	12,6 V	25,2 V	50,4 V		
Gehäuse					
Klemmengröße	16 mm ² /AWG6				
Gewicht	300 gr.				
Maße (HxBxT)	101,50x184,00x47,10 mm				
Montage	Vertikale Wandmontage - nur im Innenbereich				
Feuchte (nicht kondensierend)	Max. 95 %				
Betriebstemperatur	-35°C bis +60°C (volle Last)				
Kühlung	Naturkonvektion				
Schutzklasse	IP20				
Normen					
Sicherheit	EN60335-1, IEC62109-1				
EMC	EN61000-6-1, EN61000-6-3				

¹ Siehe auch 3.1 Einstellung Batterietyp



IMPORTANTE

Conecte siempre las baterías en primer lugar.

Para sistemas de batería de 12 V utilice sólo paneles solares de 12V (36 celdas).

Para sistemas de batería de 24V utilice sólo paneles solares de 24V (72 celdas).

Para sistemas de batería de 48V utilice sólo paneles solares de 2x24V (72 celdas).

1. Información general

La serie de controladores de carga BlueSolar utiliza el control de tensión de carga mediante modulación por ancho de pulsos (PWM, por sus siglas en inglés) combinado con un algoritmo de control multietapas.

2. Características

- Carga de las baterías de tres etapas [inicial, absorción y flotación].
- Tipo de batería: Plomo-ácido y LiFePO4 (con BMS interno)
- Protegido contra sobrecorriente.
- Protegido contra cortocircuitos.
- Protegido contra la polaridad inversa de los paneles solares y/o de la batería.
- Desconexión de las cargas consumidoras por baja tensión.
- Protección térmica.

3. Instalación

Nota importante: conecte siempre las baterías en primer lugar.

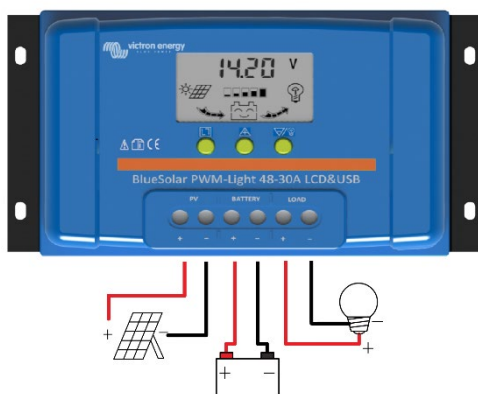

1. Conecte la batería al controlador de carga - positivo y negativo.
2. Conecte las placas solares al controlador - positivo y negativo.
3. Conecte la carga al controlador de carga - positivo y negativo.

A la hora de desinstalar, ¡siga estos pasos a la inversa!

¡Si la secuencia no se hace en este orden el controlador de carga BlueSolar podría quedar dañado!

1. Al realizar la primera instalación, asegúrese de que la batería está cargada para que el controlador de carga BlueSolar pueda reconocer el tipo de batería.
2. El cable de la batería debería ser lo más corto posible para minimizar pérdidas.
3. El controlador de carga BlueSolar sólo es adecuado para baterías de plomo-ácido y LiFePO4.
4. El controlador de carga BlueSolar sólo es adecuado para la regulación de módulos solares. Nunca conecte otra fuente de carga al controlador de carga BlueSolar.

4. PANTALLA LCD y CONFIGURACIÓN

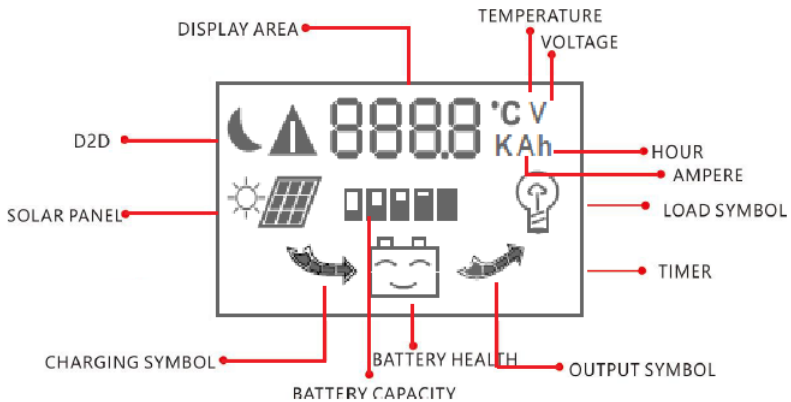

MENU: navegue entre las distintas pantallas, o introduzca/modifique ajustes manteniendo pulsado.



UP (arriba): pulse para cambiar los ajustes cuando esté en modo configuración.



DOWN (abajo): pulse para cambiar los ajustes cuando esté en modo configuración.

Botón on/off de la carga cuando está en modo H.

EN

NL

FR

DE

ES

SE

IT

Appendix

4.1 Monitorización y configuración.

Los valores entre [] corresponden a las baterías de 24V **Negrita:** ajustes para el modelo de 48V.

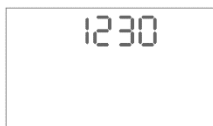

Pantalla de arranque. Tras conectar la batería la pantalla muestra el tipo de cargador y la tensión del sistema detectados.

1230=Controlador de carga BlueSolar – LCD – USB 12V|30A
 2430=Controlador de carga BlueSolar – LCD – USB 24V|30A
 4810=Controlador de carga BlueSolar – LCD – USB 48V|10A
 4820=Controlador de carga BlueSolar – LCD – USB 48V|20A
 4830=Controlador de carga BlueSolar – LCD – USB 48V|30A
 Pulse MENU  para entrar en la siguiente pantalla.



Pantalla principal. Muestra la tensión de la batería, la capacidad de la batería, y el estatus de carga y descarga.

Pulse MENU  para entrar en la siguiente pantalla.

Modificar ajustes en la pantalla principal.
 Pulse el botón MENU  durante varios segundos hasta que los números parpadeen:



Ajuste del tipo de batería.
 Ver tabla más abajo.

El valor de fábrica es b01

	Tipo de batería	Tensión de la batería	Tensión de absorción	Tensión de flotación	Ajuste de fábrica de desconexión por tensión baja	Rango de desconexión por tensión baja	Ajuste de fábrica de reconexión por tensión baja	Rango de reconexión por tensión baja
b01	PLOMO-ÁCIDO [AGM]	12,0V [24V] 48V	14,4V [28,8V] 57,6V	13,7V [27,4V] 54,8V	11,2V [22,4V] 44,8V	10,5V-12,0V en pasos de 0,1V	12,6V [25,2V] 50,4V	12,0V-13,5V en pasos de 0,1V
b02	PLOMO-ÁCIDO [Gel]	12,0V [24V] 48V	14,2V [28,4V] 56,8V	13,7V [27,4V] 54,8V	11,2V [22,4V] 44,8V	10,5V-12,0V en pasos de 0,1V	12,6V [25,2V] 50,4V	12,0V-13,5V en pasos de 0,1V
b03	PLOMO-ÁCIDO [Húmeda]	12,0V [24V] 48V	14,6V [29,2V] 58,4V	13,7V [27,4V] 54,8V	11,2V [22,4V] 44,8V	10,5V-12,0V en pasos de 0,1V	12,6V [25,2V] 50,4V	12,0V-13,5V en pasos de 0,1V
b04*	12V LiFePO4	12.8V	14.2V	13.35V	11.2V	10.5V-12.0V en pasos de 0.1V	12.6V	12.0V-13.5V en pasos de 0.1V
b05*	24V LiFePO4	25.6V	28.4V	26.7V	22.4V	21.0V-24.0V en pasos de 0.1V	25.2V	24.0V-27.0V en pasos de 0.1V

*Los controladores no tienen una entrada on/off remota. Por lo tanto, solo utilice baterías LiFePO4 con BMS integrado (como las baterías SuperPack de Victron)

NA para 48V



Pulse de nuevo en el botón MENU  y podrá hacer modificaciones:



Desconexión por baja tensión

El ajuste de fábrica es 11,2V [22,4V] 44,8V

Pulse de nuevo en el botón MENU  y podrá hacer modificaciones:



Reconexión por tensión baja

El ajuste de fábrica es 12,6V [25,2V] 50,4V



Pantalla de la tensión solar.

Muestra la tensión de los paneles solares y la capacidad de la batería.

Pulse MENU  para entrar en la siguiente pantalla.



Pantalla de corriente de carga.

Muestra la corriente del FV a la batería y estado de la carga de la misma.

Pulse MENU  para entrar en la siguiente pantalla.



Tiempo de funcionamiento de carga.

El valor de fábrica es 24H

Pulse MENU  para entrar en la siguiente pantalla.

Cambie los ajustes en la pantalla Tiempo de funcionamiento de carga. Pulse el botón MENU  durante varios segundos hasta que los números parpadeen y estará en modo de configuración de los:



Ajustes del tiempo de funcionamiento de carga.
Ver tabla más abajo.

EN

NL

FR

DE

ES

SE

IT

Appendix

H	Las cargas consumidoras puede activarse o desactivarse con el  Interruptor de encendido/apagado de las cargas consumidoras.
L	Cargas consumidoras D2D Las cargas consumidoras se activarán al anoecer y se desactivarán al amanecer.
L01-L23	La salida de cargas consumidoras se activará después del anoecer y se desactivará tras 1-23 horas.
24H	El controlador de carga BlueSolar suministrará energía a las cargas consumidoras continuamente.

Pulse de nuevo en el botón MENU  y pasará a:
(Nota: los inversores Phoenix VE.Direct pueden controlarse conectando en la conexión de la parte izquierda side connection of the remote control to the load output)



Ajuste de las cargas consumidoras: valor de activación (Tensión del panel solar)

Cuando el controlador de carga BlueSolar se ajusta en L01-L23, medirá la tensión del panel solar para decidir si es de noche o de día para activar o desactivar las cargas consumidoras. Cuánto mayor sea ese valor, más temprano se activará la salida de cargas consumidoras.
El ajuste de fábrica es 4/8/16V

Pulse de nuevo en el botón MENU  y pasará a:



Valor de demora de la activación L01-L23 (segundos)

Si el controlador de carga BlueSolar mide la tensión del panel solar y esta se encuentra por debajo de este valor, demorará la activación 10 segundos antes de volver a medirla para asegurarse de que ha anocheado.
El valor de fábrica es 10sec

Pulse de nuevo en el botón MENU  y pasará a:



Ajuste de la protección contra cortocircuitos.

Algunas cargas consumidoras inductivas o capacitivas activarán la protección contra cortocircuitos durante el arranque. Por lo tanto, puede desactivar esta protección manualmente. Sc.F=OFF, Sc.n=ON. El ajuste de fábrica es ON.
El valor de fábrica es Sc.n.



Pantalla de corriente de cargas consumidoras. Muestra la corriente de las cargas consumidoras y la capacidad de la batería.

Pulse MENU  para entrar en la siguiente pantalla.



Pantalla de la tensión USB. Muestra la tensión USB.
5V
2A máx.

Pulse MENU  para entrar en la siguiente pantalla.



Pantalla de temperatura del controlador. Si el controlador se calentara durante su funcionamiento, se desactivará automáticamente y esperará a que la temperatura caiga a un valor normal para volver a activarse.

Pulse MENU  para entrar en la pantalla principal.

5. Alarmas

Temperatura alta

Temperatura $<85^{\circ}\text{C}$, el controlador funciona normalmente.

Cuando la temperatura $\geq 85^{\circ}\text{C}$, el controlador se pondrá en primera fase de protección:

1. El controlador bajará la corriente de entrada FV para bajar su temperatura, pero no afectará a las cargas consumidoras. La pantalla LCD no muestra ninguna alarma.

Cuando la temperatura $\geq 90^{\circ}\text{C}$, el controlador se pondrá en segunda fase de protección:

2. El controlador cortará la entrada de corriente FV. La salida de cargas consumidoras se desactivará. En la pantalla LCD aparecerá el icono de alarma por temperatura alta para avisar al usuario.

Cuando la temperatura baje por debajo de 82°C , el controlador activará de nuevo la entrada FV y la salida de cargas consumidoras. El icono de alarma desaparece.



Tensión baja

Un icono de batería vacía parpadeante indica que la batería está descargada por debajo del valor LVD (desconexión por baja tensión). El controlador de carga BlueSolar ha desactivado la entrada. El usuario deberá cargar la batería hasta llegar al valor LVR (reconexión por baja tensión), tras lo cual el controlador de carga BlueSolar volverá a activar la salida.



Protección contra cortocircuitos.

Esta pantalla aparece cuando se produce un cortocircuito. El controlador de carga BlueSolar desconectará la salida y esperará 30 s antes de intentar reiniciarla. El usuario deberá comprobar cuál es el problema y resolverlo a tiempo.



Protección de sobrecorriente.

Esta pantalla indica que hay sobrecorriente en la salida. El controlador de carga BlueSolar desconectará la salida y esperará 30 s antes de intentar reiniciarla. El usuario deberá comprobar cuál es el problema y resolverlo a tiempo.

Desconexión tras 60 s al alcanzar el 110%-130% de carga
Desconexión tras 5 s al alcanzar el 130%-160% de carga



6. Especificaciones

Controlador de carga BlueSolar	12V/24V 30A	48V 10A	48V 20A	48V 30A
Tensión de la batería	Selección automática 12/24V		48V	
Corriente de carga y cargas consumidoras	30A	10A	20A	30A
Modo de carga	PWM, Tiempo y Control de luminosidad			
Desconexión automática de las cargas consumidoras	Sí			
Tensión solar máxima	55V		100V	
Rango de tensión FV	15-28V	30-55V	60-100V	
Autoconsumo	<15mA			
Protecciones	Polaridad inversa de los paneles solares. Polaridad inversa de la batería. Desconexión por baja tensión. 110%-130% de carga: desconexión tras 60 segundos. 130%-160% de carga: desconexión tras 5 segundos. Desconexión inmediata en caso de cortocircuito. Protección de sobrecalentamiento.			
Panel solar				
Paneles solares recomendados	36cell	72cell	2X72 celdas en serie o 4x36 celdas en serie	
Potencia de entrada solar máxima	360W	720W	480W	960W 1440W
Salidas USB				
Tensión	5V			
Corriente	2A (total de 2 salidas USB)			
Valores predeterminados				
Carga de absorción (b01) ¹	14,4V	28,8V	57,6V	
Carga de flotación (b01) ¹	13,7V	27,4V	54,8V	
Desconexión de las cargas consumidoras (b01) ¹	11,2V	22,4V	44,8V	
Reconexión de las cargas consumidoras (b01) ¹	12,6V	25,2V	50,4V	
Carcasa				
Tamaño de los terminales	16mm ² / AWG6			
Peso	300gr			
Dimensiones (al x an x p)	101,50x184,00x47,10 mm			
Montaje	Montaje vertical de pared, solo interiores			
Humedad (sin condensación)	Max. 95%			
Temperatura de trabajo	-35°C a +60°C (carga completa)			
Refrigeración	Convección natural			
Clase de protección	IP20			
Normativas				
Seguridad	EN60335-1, IEC62109-1			
EMC	EN61000-6-1, EN61000-6-3			

¹ Ver también 3.1 Ajuste tipo de batería.

EN

NL

FR

DE

ES

SE

IT

Appendix

VIKTIGT

Anslut alltid batterierna först.

Använd endast 12 V (36 cell) solcellspaneler till 12 V-batterisystem.

Använd endast 24V (72 cell) solcellspaneler till 24V-batterisystem.

Använd endast 2x24 V (72 cell) solcellspaneler i serie till 48 V-batterisystem.

1. Allmän information

Laddningsregulatorn BlueSolar använder pulsbreddsmodulerad (PWM efter engelskans Pulse Width Modulation) laddningsspänningskontroll tillsammans med en laddningskontrollsalgoritm i flera steg.

2. Funktioner

- Batteriladdning i tre steg (bulk, absorption och float).
- Batterityp Blysyra och LiFePO₄ (med intern BMS)
- Skyddad mot överström.
- Skyddad mot kortslutning.
- Skydd mot omvänd polaritet vid anslutning till solcellspaneler och/eller batteri.
- Belastningsbortkoppling vid låg spänning (LVD)
- Temperaturskydd.

3. Installation

Obs: anslut alltid batterierna först.

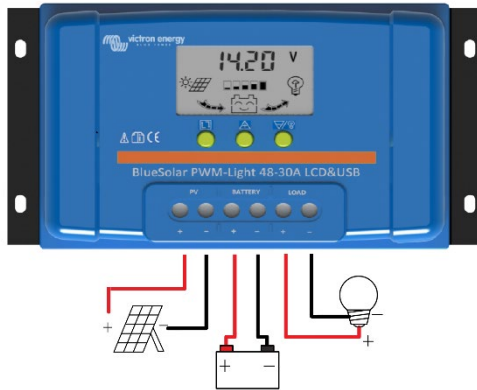

1. Anslut batteriet - plus och minus.
2. Anslut solcellspanelen - plus och minus.
3. Anslut belastningen - plus och minus.

Vid avinstallering gäller omvänd ordning.

En felaktig ordning kan skada laddningsregulatorn BlueSolar!

1. Säkerställ att batteriet är laddat så att laddningsregulatorn BlueSolar kan känna igen batteritypen innan den första installationen.
2. Batterikabeln bör vara så kort som möjligt för att minimera förluster.
3. Den passar endast till blysyrebatterier och LiFePO4-batterier.
4. Laddningsregulatorn BlueSolar är endast lämplig för att reglera solcellsmoduler. Anslut aldrig någon annan laddningskälla till laddningsregulatorn BlueSolar.

4. LCD-DISPLAY och INSTÄLLNINGAR

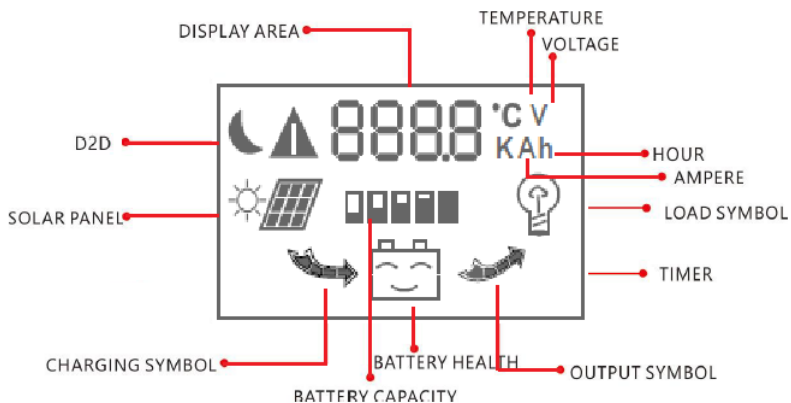

MENY: växla mellan olika displayer eller tryck ned länge för att gå in/ur inställningar.



UPP: tryck för att ändra inställningar när den är i inställningsläge.



NED: tryck för att ändra inställningar när den är i inställningsläge.
Belastning av/på-knapp när den är i H-läge.

EN

NL

FR

DE

ES

SE

IT

Appendix

4.1 Övervakning och inställningar

Värden inom [] är för inställningar för 24 V-batterier Fetstil är inställningarna för 48 V.

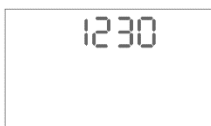

Startdisplay. Efter att batteriet har anslutits visar skärmen vilken modell solcellsaddaren är samt vilken systemspänning den har.
 1230= BlueSolar laddningsregulator– LCD – USB 12 V|30 A
 2430= BlueSolar laddningsregulator– LCD – USB 24V|30 A
 4810= BlueSolar laddningsregulator– LCD – USB 48V|10A
 4820= BlueSolar laddningsregulator– LCD – USB 48V|20A
 4830= BlueSolar laddningsregulator– LCD – USB 48V|30 A

Tryck på MENY  för att gå vidare till nästa display.



Huvuddisplay. Den visar batterispänning, laddningstillstånd batteri, laddnings- och urladdningsstatus.

Tryck på MENY  för att gå vidare till nästa display.

Ändra inställningar huvuddisplay.

Tryck ned MENY -knappen i flera sekunder till displayen blinkar, du hamnar i:



Batteritypsinställning.
Se tabell nedan.

Fabriksinställningen är b01

	Batterityp	Batterispänning	Absorbtionsspänning	Floatspänning	Låg spänning frånkoppling fabriksinställning	Låg spänning frånkoppling intervall	Låg spänning återkoppling fabriksinställning	Låg spänning återkoppling intervall
b01	BLYSYRA [AGM]	12,0V [24V] 48V	14,4V – 28,8V 57,6V	13,7V – 27,4V 54,8V	11,2V [22,4V] 44,8V	10,5V-12,0V i steg av 0,1V	12,6V [25,2V] 50,4V	12,0V-13,5V i steg av 0,1V
b02	BLYSYRA [Gel]	12,0V [24V] 48V	14,2V [28,4V] 56,8V	13,7V [27,4V] 54,8V	11,2V [22,4V] 44,8V	10,5V-12,0V i steg av 0,1V	12,6V [25,2V] 50,4V	12,0V-13,5V i steg av 0,1V
B03	BLYSYRA (Våt)	12,0V [24V] 48V	14,6V [29,2V] 58,4V	13,7V [27,4V] 54,8V	11,2V [22,4V] 44,8V	10,5V-12,0V i steg av 0,1V	12,6V [25,2V] 50,4V	12,0V-13,5V i steg av 0,1V
b04*	12V LiFePO4	12.8V	14.2V	13.35V	11.2V	10.5V-12.0V i steg av 0.1V	12.6V	12.0V-13.5V i steg av 0.1V
b05*	24V LiFePO4	25.6V	28.4V	26.7V	22.4V	21.0V-24.0V i steg av 0.1V	25.2V	24.0V-27.0V i steg av 0.1V

*Regulatorerna har ingen fjärrstyrd på/av-ingång. Använd därför endast LiFePO4-batterier med integrerad BMS (som Victron SuperPack).
NA för 48 V

Tryck återigen ner MENY--knappen och du hamnar i:



**Låg spänning
frånkoppling**
Fabriksinställningen är
11,2 V [22,4 V] **44,8 V**

Tryck återigen ner MENY--knappen och du hamnar i:



**Låg spänning
återinkoppling**
Fabriksinställningen är
12,6V [25,2V] **50,4V**



Display för solcellsspänning. Den visar solcellsspänning och batteriets kapacitetsstatus.

Tryck på MENY  för att gå vidare till nästa display.



Display för laddningsström: Den visar ström från solcell till batteri och batteriets laddningstillstånd.

Tryck på MENY  för att gå vidare till nästa display.



Driftläge belastning.

Fabriksinställningen är 24 H

Tryck på MENY  för att gå vidare till nästa display.

Ändra inställningar i displayen för driftläge för belastning.

Tryck ned MENY--knappen i flera sekunder till numret blinkar, du är i inställningsläget för:



Inställningar för driftläge belastning.

Se tabell nedan.

H	Denna belastning kan kopplas på och ifrån via  av/på-brytaren för belastning.
L	Belastning D2D Belastningen kopplas på vid solnedgången och kopplas från vid soluppgången.
L01-L23	Belastningsutgången kopplas på efter solnedgången och kopplas ifrån efter 1-23 timmar.
24 tim	Laddningsregulatorn BlueSolar förser belastningen kontinuerligt med ström.

Tryck ner MENY -knappen igen och du hamnar på:
(Obs: Växelriktarna Phoenix VE.Direct kan styras genom att kopplas till anslutningen på vänster sida på fjärrkontrollen till belastningsutgången)



Belastningsinställning: utlösningvärde (solcellspanelspänning)
När driftläget är inställt på L01 L23 kommer laddningsregulatorn BlueSolar att mäta spänningen i solcellspanelen för att bestämma om det är natt eller dag för att koppla på eller ifrån belastningen. Ju högre värde desto tidigare kopplar den på belastningsutgången.
Fabriksinställningen är 4/8/16V

Tryck ner MENY -knappen igen och du hamnar på:



L01-L23 värde utlösningfördröjning (sekunder)

När laddningsregulatorn BlueSolar mäter att solpanelsspänningen är under detta värde kommer den att vänta i 10 sekunder och sen mäta igen för att säkerställa att det börjar skymma.
Fabriksinställningen är 10 sek-

Tryck ner MENY -knappen igen och du hamnar på:



Inställning för kortslutningsskydd

Vissa induktiva eller kapacitiva belastningar kommer att utlösa kortslutningsskyddet vid start. Därför kan skyddet avaktiveras manuellt. Sc.F=AV, Sc.n=PA. Standard är PÅ.
Fabriksinställningen är Sc.n.



Display för belastningsström. Den visar belastningsström och batterikapacitet.

Tryck på MENY  för att gå vidare till nästa display.



Display för USB-spänning. Den visar USB-spänningen 5V/2A max

Tryck på MENY  för att gå vidare till nästa display.



Display för regulatorns inre temperatur. Om laddningsregulatorn blir varm under drift kommer den att stängas av och vänta tills temperaturen har sjunkit ned till normal nivå och startar sedan om igen.

Tryck ned MENY -knappen för att komma till huvuddisplayen-.

5. Larm

EN

NL

FR

DE

ES

SE

IT

Appendix

Hög temperatur

Temp <85°C, regulatoren fungerar normalt.

Om temperaturen är $\geq 85^\circ\text{C}$, går regulatoren in i första skyddsfasen:

1. Regulatoren kommer att sänka solcellsingångsströmmen, för att sänka temperaturen, men belastningen fungerar normalt. LCD-displayen visar inte något larm.

Om temperaturen är $>90^\circ\text{C}$, kommer regulatoren att gå in i andra skyddsfasen:

2. Regulatoren kommer att stänga av solcellsingångsströmmen. Avstängnings belastningsutgång. En ikon för hög temperatur kommer att visas på lcd-displayen för att varna användaren.

Om temperaturen är under 82°C , kommer regulatoren att återigen starta solcellsingången och belastningsutgången. Larmikonen försvinner.



Låg spänning

Om symbolen för tomt batteri blinkar betyder det att batteriet har laddats ur under VD.spänningsnivån.

Laddningsregulatoren BlueSolar har då kopplat från utgången. Användaren bör ladda batteriet upp till dess återkopplingsvärde vid låg spänning och därefter kommer laddningsregulatoren BlueSolar att återkoppla belastningstillståndet.



Kortslutningsskydd.

Den här displayen innebär att kortslutningsskyddet är aktiverat. Laddningsregulatoren BlueSolar kommer att koppla från belastningsutgången och vänta i 30 sekunder och därefter försöka återkoppla den. Användaren bör kontrollera och få bort problemet i tid.



Skydd mot överström.

Den här displayen innebär att det förekommer överström i belastningen. Laddningsregulatoren BlueSolar kommer att koppla från belastningen och vänta i 30 sekunder och därefter försöka återkoppla den. Användaren bör kontrollera och få bort problemet i tid.

Stängs av efter 60 sek vid 110 %-130 % belastning.

Stängs av efter 5 sek vid -130 %-160 % belastning



6. Specifikationer

Laddningsregulator Blue Solar	12V/24V 30A	48V 10A	48V 20A	48V 30A
Batterispänning	12/24 volt autoval		48V	
Laddnings- och belastningsström	30A	10A	20A	30A
Laddningsläge	PWM, tid- och ljuskontroll			
Automatisk frånkoppling av belastning	Ja			
Maximal solcellsspänning	55V		100V	
Solpanelsintervall	15-28V	30-55V	60-100V	
Egenkonsumtion	<15mA			
Skydd	Omvänd polaritetsanslutning av solcellspaneler. Omvänd polaritetsanslutning av batteriet. Frånkoppling vid låg spänning. 110 %-130 % belastning: Stänger av efter 60 sek. 130%-160% belastning: Stänger av efter 5 sek. Kortslutning: omedelbar avstängning Skydd mot övertemperatur.			
Solcellspaneler				
Rekommenderad solcellspanel	36 cell	72 cell	2X72 cell i serie eller 4x36 cell i serie	
Maximal solcellsingångsström	360W	720W	480W	960W 1440W
USB-utgångar				
Spänning	5V			
Ström	2 A (totalt från 2 USB-utgångar)			
Standardinställningar				
Absorptionsladdning (b01) ¹	14,4V	28,8V	57,6V	
Floatladdning (b01) ¹	13,7V	27,4V	54,8V	
Belastningsfrånkoppling (b01)) ¹	11,2V	22,4V	44,8V	
Återinkoppling belastning (b01) ¹	12,6V	25,2V	50,4V	
Hölje				
Polstorlek	16mm ² / AWG6			
Vikt	300 gr			
Dimension (h x b x d)	101.50x184.00x47.10 mm			
Montering	Vertikal väggmontering Endast inomhus			
Fuktighet (ej kondenserande)	Max. 95%			
Drifttemperatur	-35°C till +60°C (full last)			
Kylning	Naturlig konvektion			
Skyddsklass	IP20			
Standarder				
Säkerhet	EN60335-1, IEC62109-1			
EMC	EN61000-6-1, EN61000-6-3			

¹ Se även 3.1 Batteritypsinställning.



IMPORTANTE

Collegare sempre prima la batteria.

- Per sistemi di batterie da 12V utilizzare solo pannelli solari da 12V (36 celle).
- Per sistemi di batterie da 24V utilizzare solo pannelli solari da 24V (72 celle).
- Per sistemi di batterie da 48V utilizzare solo pannelli solari da 24V (72 celle) in serie.

1. Informazioni Generali

I Regolatori di carica BlueSolar impiegano un controllo di tensione di carica con Modulazione di durata di impulso (PWM), in combinazione con un algoritmo di regolazione di carica multifase

2. Caratteristiche

- Ricarica batteria in 3 fasi [prima fase di carica – assorbimento – mantenimento]
- Tipo di batteria: Piombo acido e LiFePO4 (con BMS interno)
- Protezione da sovracorrente.
- Protezione da cortocircuito.
- Protezione contro il collegamento con polarità inversa dei pannelli solari e/o della batteria.
- Tensione di disconnessione del carico.
- Protezione della temperatura

3. Installazione

Nota importante: Collegare sempre prima la batteria.

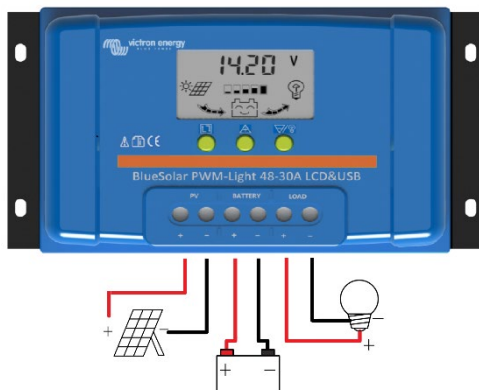

6. Collegare la batteria al polo positivo e negativo del regolatore di carica.
7. Collegare il modulo solare al polo positivo e negativo del regolatore di carica.
8. Collegare il carico al polo positivo e negativo del regolatore di carica.

Per la disinstallazione si segue l'ordine inverso!

Un diverso ordine della sequenza può danneggiare il Regolatore di carica BlueSolar!

5. Assicurarsi che la batteria sia carica, per consentire al Regolatore di carica BlueSolar di riconoscere il tipo di batteria prima dell'installazione.
6. Il cavo della batteria deve essere il più corto possibile, per minimizzare le perdite.
7. Il Regolatore di carica BlueSolar è compatibile solo con batterie al piombo acido e LiFePO4.
8. Il Regolatore di carica BlueSolar è indicato solo per regolare i moduli solari. Non collegare mai un'altra sorgente di carica al Regolatore di carica BlueSolar.



victron energy

9. DISPLAY LCD e IMPOSTAZIONI

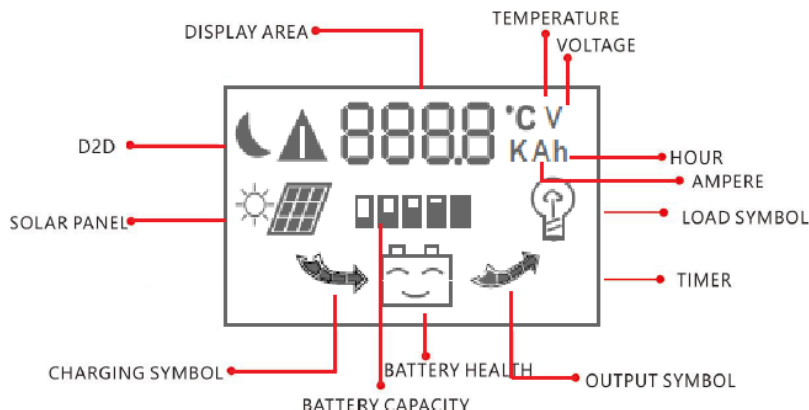

MENU: passare da un display all'altro o entrare/uscire dalle impostazioni premendolo a lungo.



UP: premerlo per cambiare le impostazioni quando ci si trova nella modalità di configurazione.



DOWN: premerlo per cambiare le impostazioni quando ci si trova nella modalità di configurazione.

Pulsante carico on/off quando ci si trova in modalità H.

4.1 Monitoraggio e impostazioni

I valori fra [] si riferiscono alle impostazioni di batterie da 24 V.. I **bulloni** sono per le impostazioni a 48V.

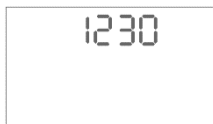

Display di Avvio. Dopo aver collegato le batterie, appariranno il tipo di caricabatterie e la tensione della batteria rilevata.

1230=Regolatore di carica BlueSolar – LCD – USB 12V|30A

2430=Regolatore di carica BlueSolar – LCD – USB 24V|30A

4810=Regolatore di carica BlueSolar – LCD – USB 48V|10A

4820=Regolatore di carica BlueSolar – LCD – USB 48V|20A

4830=Regolatore di carica BlueSolar – LCD – USB 48V|30A

Premere MENU  per entrare nella seguente schermata.

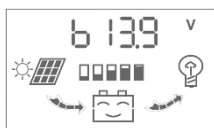

Schermata principale. Mostra la tensione batteria, lo stato di carica della batteria, lo stato di carica e di scarica. Premere MENU  per entrare nella seguente schermata.

Modifica impostazioni nella Schermata principale. Premere il pulsante MENU  per alcuni secondi, finché i numeri lampeggiano e si entrano in:



Impostazioni tipo di batteria. Vedere la tabella seguente.

L'impostazione di fabbrica è b01

	Tipo di batteria	Tensione batteria	Tensione di assorbimento	Tensione e di mantenimento	Tensione bassa scollegare impostazioni di fabbrica	Tensione bassa scollegare campo	Tensione bassa ricollegare impostazioni di fabbrica	Tensione bassa ricollegare campo
b01	PIOMBO-ACIDO [AGM]	12.0V [24V] 48V	14,4V [28,8V] 57,6V	13,7V [27,4V] 54,8V	11,2V [22,4V] 44,8V	10,5V-12,0V ad intervalli di 0.1V	12,6V [25,2V] 50,4V	12,0V-13,5V ad intervalli di 0.1V
b02	PIOMBO-ACIDO [Gel]	12.0V [24V] 48V	14,2V [28,4V] 56,8V	13,7V [27,4V] 54,8V	11,2V [22,4V] 44,8V	10,5V-12,0V ad intervalli di 0.1V	12,6V [25,2V] 50,4V	12,0V-13,5V ad intervalli di 0.1V
b03	PIOMBO-ACIDO [Bagnato]	12.0V [24V] 48V	14,6V [29,2V] 58,4V	13,7V [27,4V] 54,8V	11,2V [22,4V] 44,8V	10,5V-12,0V ad intervalli di 0.1V	12,6V [25,2V] 50,4V	12,0V-13,5V ad intervalli di 0.1V
b04*	12V LiFePO4	12,8V	14,2V	13,35V	11,2V	10,5V-12,0V ad intervalli di 0.1V	12,6V	12,0V-13,5V ad intervalli di 0.1V
b05*	24V LiFePO4	25,6V	28,4V	26,7V	22,4V	21,0V-24,0V ad intervalli di 0.1V	25,2V	24,0V-27,0V ad intervalli di 0.1V

*I regolatori non hanno un'entrata remota on/off. Pertanto, utilizzare solo batterie LiFePO4 con BMS integrato (come le batterie Victron SuperPack)
NA per 48V

premere nuovamente il tasto MENU  e si entra in:



Disconnessione per bassa tensione
Le impostazioni di fabbrica sono 11,2V [22,4V] **44,8V**

premere nuovamente il tasto MENU  e si entra in:



Riconnessione per bassa tensione
Le impostazioni di fabbrica sono 12,6V [25,2V] **50,4V**



Schermata Tensione Solare. Mostra la tensione del Pannello Solare, stato capacità batteria.

Premere MENU  per entrare nella seguente schermata.



Schermata Corrente di carica. Mostra: corrente da FV a batteria e stato di carica.

Premere MENU  per entrare nella seguente schermata.



Modalità funzionamento carico.

L'impostazione di fabbrica è 24H

Premere MENU  per entrare nella seguente schermata.

Cambiare Impostazioni nella schermata Modalità funzionamento carico.

Premere il pulsante MENU  per alcuni secondi, finché i numeri lampeggino e si entri nella modalità di configurazione per:



Impostazioni Modalità funzionamento carico.

Vedere la tabella seguente.

H	Il carico si può accendere/spegnere mediante  l'interruttore Carico on/off.
L	Carico D2D. Il carico si accenderà al tramonto e si spegnerà all'alba.
L01-L23	L'uscita del carico si accenderà dopo il tramonto e si spegnerà dopo 1-23 ore.
24H	Il Regolatore di carica BlueSolar alimenterà ininterrottamente il carico.

Premere nuovamente il tasto MENU  e si entra in:

(Nota: gli inverter Phoenix VE.Direct possono essere controllati collegando la connessione sulla sinistra del telecomando all'uscita del carico)



Impostazioni Carico: valore di attivazione (Tensione Pannello Solare)

Quando la modalità di funzionamento è L01-L23, il regolatore di carica misura la tensione del pannello solare per decidere se è giorno o notte e accendere o spegnere il carico. Quanto più alto sia questo valore, prima accenderà l'uscita del carico.

Le impostazioni di fabbrica sono 4/8V/16V

Premere nuovamente il tasto MENU  e si entra in:



Valore ritardo attivazione L01-L23 (Secondi)

Quando il Regolatore di carica rileva una tensione del pannello solare inferiore a questo valore, ritarderà per 10

Premere nuovamente il tasto MENU  e si entra in:



secondi ed eseguirà una nuova misurazione per assicurarsi che sia di notte. L'impostazione di fabbrica è 10 sec

Impostazioni protezione contro cortocircuito.

Alcuni carichi induttivi o capacitivi attiveranno la protezione contro il cortocircuito durante l'avvio. Pertanto, la protezione SC può essere disattivata manualmente. Sc.F=OFF, Sc.n=ON. Il predefinito è ON. L'impostazione di fabbrica è Sc.n.



Schermata Corrente di carico. Mostra: corrente di carico e capacità batteria.

Premere MENU  per entrare nella seguente schermata.



Schermata Tensione USB. Mostra: tensione USB **5V (max 2A)**

Premere MENU  per entrare nella seguente schermata.



Schermata controllo temperatura. Se il regolatore si surriscalda, si arresta automaticamente ed attende che la temperatura torni a un livello normale, quindi si avvia nuovamente.

Premere MENU  per entrare nella Schermata principale.

5. Allarmi

Surriscaldamento

Temp <85°C, il regolatore funziona normalmente.
Quando temp ≥ 85°C, il regolatore entra in prima fase di protezione:

- Il regolatore diminuisce la corrente di ingresso FV per abbassare la temp del regolatore, ma il carico funziona normalmente. Sul display LCD non appaiono allarmi.

Quando temp > 90°C, il regolatore entra in seconda fase di protezione:

- Il regolatore scollega la corrente di ingresso del FV. Scollegamento uscita del carico. Sul display LCD appare un'icona di allarme per alta temperatura, per avvisare l'utente.

Quando la temp è inferiore a 82°C, il regolatore attiverà nuovamente l'ingresso del FV e l'uscita del carico. L'icona di allarme scompare.



Tensione bassa.

Quando il simbolo di batteria scarica lampeggia, significa che la batteria è più scarica della tensione LVD. Il regolatore di carica ha disattivato l'uscita. L'utente deve caricare la batteria fino a superare la tensione di riconnessione per bassa tensione LVR, quindi il Regolatore di carica BlueSolar ripristinerà lo stato dell'uscita.



Protezione contro cortocircuito.

Questa schermata indica che si è verificata una protezione contro cortocircuito. Il regolatore disattiva l'uscita, attende 30 sec e poi cerca di riattivarla. L'utente deve verificare ed eliminare il problema in tempo.



Protezione contro sovracorrente.

Questa schermata indica che si è verificata una sovracorrente dell'uscita. Il regolatore disattiva l'uscita, attende 30 sec e poi cerca di riattivarla. L'utente deve verificare ed eliminare il problema in tempo.
Arresto dopo 60 sec in caso di carico al 110%-130%.
Arresto dopo 60 sec in caso di carico al 130%-160%.



6. Specifiche

Regolatore di carica BlueSolar	12V/24V 30A		48V 10A	48V 20A	48V 30A
Tensione della batteria	12/24V con selezione automatica		48V		
Corrente di Carica e del Carico	30A		10A	20A	30A
Modalità di carica	PWM, Controllo Tempo e Illuminazione				
Disconnessione automatica del carico	Sì				
Tensione fotovoltaica massima	55V		100V		
Intervallo Tensione Solare	15-28V	30-55V	60-100V		
Autoconsumo	<15mA				
Protezioni	Collegamento con polarità inversa dei pannelli solari. Collegamento con polarità inversa della batteria. Disconnessione per bassa tensione. Carico al 110%-130%: Si arresta dopo 60 sec. Carico al 130%-160%: Si arresta dopo 5 sec. Cortocircuito: arresto immediato. Protezione contro sovratemperatura.				
Pannello solare					
Pannelli solari raccomandati	36 celle	72 celle	2X72 celle in serie o 4x36 celle in serie		
Massima potenza solare di ingresso	360W	720W	480W	960W	1440W
Uscite USB					
Tensione	5V				
Corrente	2A (complessiva per le 2 uscite USB)				
Impostazioni di fabbrica					
Carica di assorbimento (b01) ¹	14,4V	28,8V	57,6V		
Carica di mantenimento (b01) ¹	13,7V	27,4V	54,8V		
Disconnessione del carico (b01) ¹	11,2V	22,4V	44,8V		
Riconnessione del carico (b01) ¹	12,6V	25,2V	50,4V		
Involucro					
Dimensione morsetto	16mm ² / AWG6				
Peso	300gr				
Dimensioni (a x l x p)	101,50x184,00x47,10 mm				
Montaggio	Supporto a muro verticale Solo per interni				
Umidità (senza condensa)	Max. 95%				
Temperatura di esercizio	da -35°C a +60°C (pieno carico)				
Raffreddamento	Convezione naturale				
Categoria di protezione	IP20				
Normative					
Sicurezza	EN60335-1, IEC62109-1				
Compatibilità elettromagnetica	EN61000-6-1, EN61000-6-3				

¹ Vedere anche 3.1 Impostazioni tipo di batteria.



EN - Mechanical drawing.
NL - Mechanische tekening.
FR - Schémas mécaniques.
DE - Technische Zeichnung
ES - Dibujo mecánico.
SV - Mekanisk ritning.
IT - Disegni meccanici

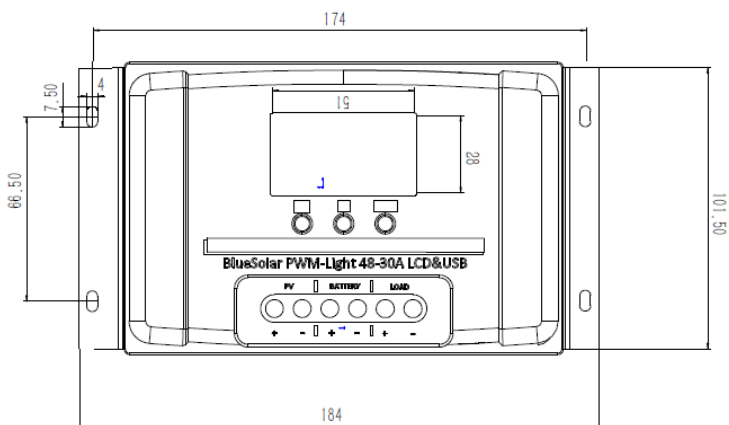

EN

NL

FR

DE

ES

SE

IT

Appendix



victron energy

Victron Energy Blue Power

Distributor:

Serial number:

Version : 04

Date : February 4th, 2019

Victron Energy B.V.
De Paal 35 | 1351 JG Almere
PO Box 50016 | 1305 AA Almere | The Netherlands

General phone : +31 (0)36 535 97 00
E-mail : sales@victronenergy.com

www.victronenergy.com