



**XDH10TT-AM**

High Mount

**XDL15TT-AM**

Low Mount

High security wired tri-technology  
external detectors with anti-masking

 **Pyronix**<sup>®</sup>  
[www.pyronix.com](http://www.pyronix.com)



# XDH10TT-AM

Installation height 2.4m

## High Mount Installation - XDH

The XDH detectors optical configuration is designed for an installation height of 2.4m.

These detectors are used to ensure maximum protection with a 90 degree high density volumetric coverage of the protected area, with 78 detection zones over 5 planes.

## Volumetric Detection Range

A range of up to 10m covering an area of 90°.

Volumetric coverage using the optional XD-WALLBRACKET

Curtain coverage using the supplied fixed mask, XD-WALLBRACKET mounted on the XD45D-ADAPTER

XD-LENS5 detection pattern

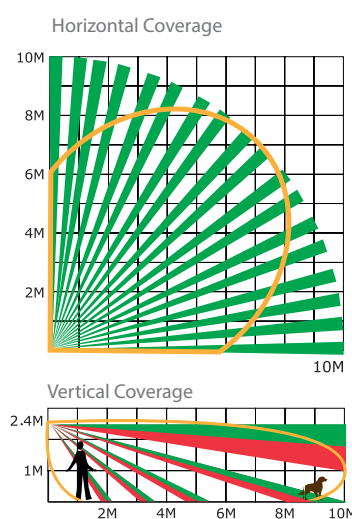
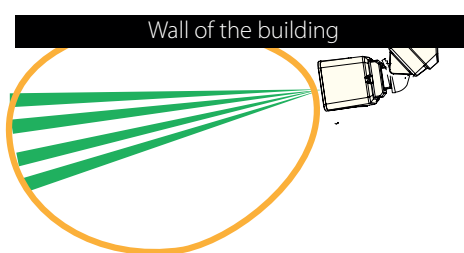
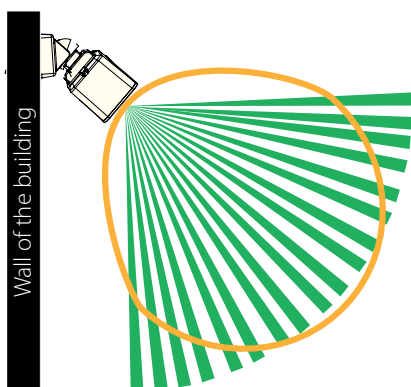

## Included Accessories

**XD-LENS 5**  
 Volumetric lens for the XDH series of detectors.  
 90 degree coverage  
 78 zone edges  
 5 planes

**Fixed masking grid**  
 There are two fixed masking grids supplied with the detector. These grids can be used to create a curtain coverage. When used in conjunction with the XD-WALL-BRACKET and the XD45D-ADAPTER, you can protect the area beside a house, as seen in the lens diagram above.

**Flexible masking grid**  
 This flexible masking grid allows the creation of targeted protection areas by removing strips from the grid. This grid is also a very useful accessory when it is necessary to block the detection of unwanted areas such as a main road, trees or bushes etc.





# XDL15TT-AM

Installation height 1.2m

## Low Mount Installation - XDL

The XDL detectors optical configuration is designed for an installation height of 1.2m. They are used for installations where a maximum animal immunity is required (up to 3.5kg).

## Perimeter Detection Range

A perimeter detector with a range of up to 15m, covering a narrow beam area of 14° with 6 zones.

## 30m Detection Range Configuration

Mounting two XDL15TT-AM detectors back to back on the XD-FIXEDBRACKET will allow a narrow beam perimeter coverage with a range of up to 30m. Pay attention to use 2 different MW frequencies to avoid interference.

## Adjustable PIR Range

The PIR range can be adjusted by moving the PCB up and down within the housing. This ensures the detector fits most terrain and installation requirements.

30m perimeter protection using two detectors mounted on the XD-FIXEDBRACKET

Horizontal Coverage

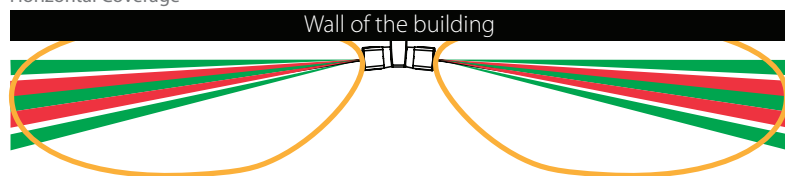

15m perimeter protection using the XD-WALLBRACKET with XD45D-ADAPTER

Horizontal Coverage

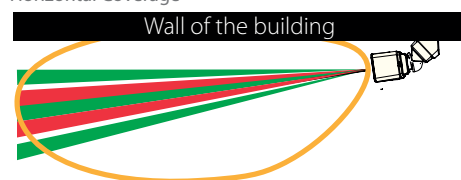

## XD-LENS4 detection pattern

Horizontal Coverage

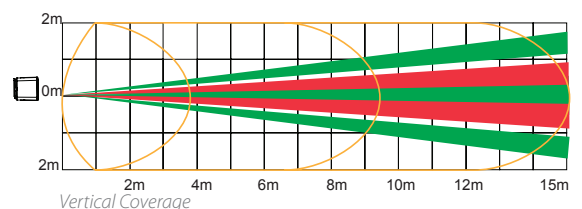

Vertical Coverage

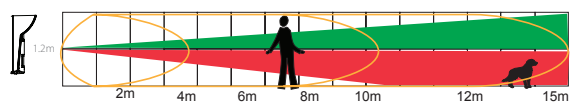

## Included Accessories

XD-LENS 4



Long range lens for the XDL series of detectors.

14 degree coverage

6 zone edges

1 plane

# XD Features

## Weatherproof Housing

The housing of the XD is made of 3mm thick polycarbonate plastics. To enhance the durability and protect the electronics from adverse weather conditions. It is also moulded with an ultraviolet stabilising material to prevent the dis-coloration over time. The hood of the XD detector is designed for adding further protection to the front of the detector from high density rain and snow.

## Different Microwave Frequencies

These options allow for the mounting of two detectors in close proximity without the risk of microwave interference. The different frequencies are clearly shown by a colour coded sticker on the side of the packaging.



## Built-in Walk Test Buzzer

Bright sunlight can make it difficult to see the alarm LEDs of the detector from a distance, therefore the XD detectors have a built-in walk test buzzer.

This enables the installer to perform an easy and quick walk test during the installation process; with an audible indication of a presence in the detection area. Note: the buzzer can be disabled if it is not required.

## Sealed Optics

The lens collet is designed to firmly hold the lens in place and create a stable environmental chamber between it and the PIR sensor. The rubber gasket on the lens and the foam gasket on the PIR sensor seal the chamber against all weather conditions, humidity and protect the sensors from possible insect infestation and/or internal air movement.

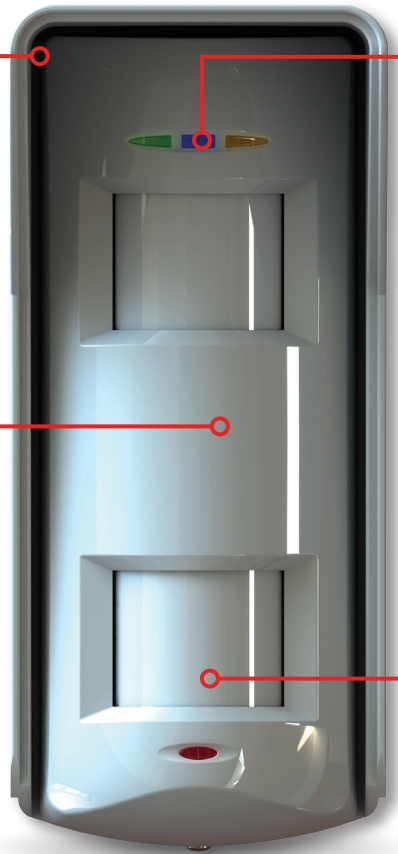
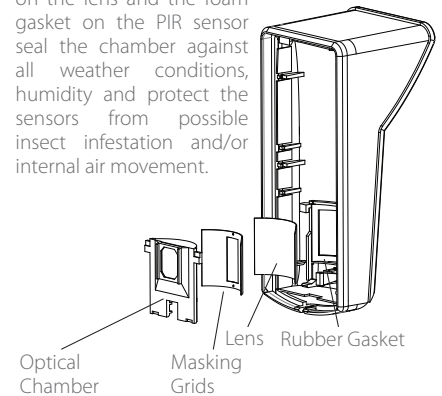

Terminal block modules

PCB connector

Cable entry

Bracket adjustment window and cable entry

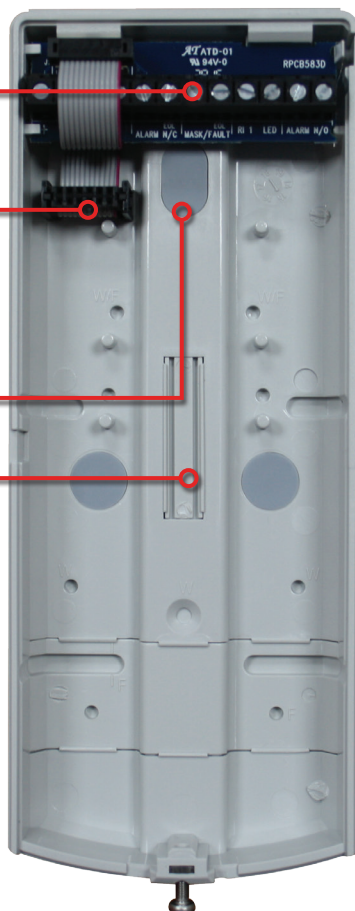

Connector to the terminal block module

EOL resistors for the mask/fault relay

EOL resistors for the tamper relay

DIP switches for programming

Microwave range adjustment

Anti-mask range adjustment

Front and back tamper

EOL resistors for the alarm relay

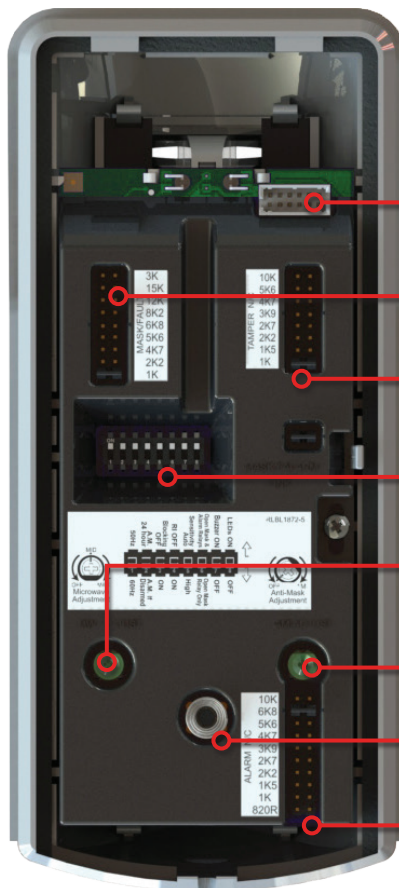



# XD Features

## Tri-Signal Detection Logic

The detection of human presence is based on the advanced analysis of the activation sequence of the microwave movement sensor and the two independent PIR sensors. All three sensors have to activate to generate an alarm condition. Using Tri-Signal Detection Logic enhances the detector's immunity to environmental disturbances simultaneously.

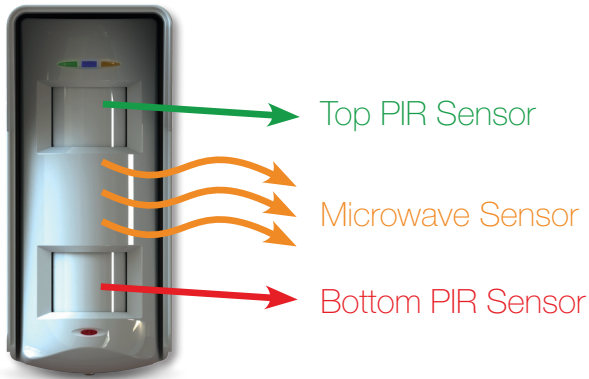

## Tri-Detection Range

The range of XD detectors is determined by the combined range of the three detection technologies used in the products: two independent PIR sensors and one microwave detector.

### No Alarm Activation

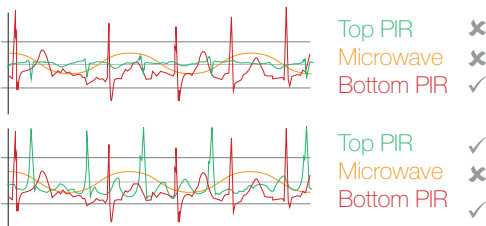

### Alarm Activation

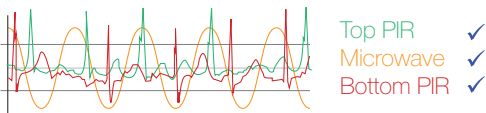

## Digital Temperature Compensation

The XD detectors digitally adjust themselves to maintain detection range in hot and humid environments, even when the environmental temperature becomes similar to that of the human body.

## Vegetation Sway Elimination Filter

Swaying vegetation in windy weather conditions can cause false alarms on the microwave sensor. The XD detectors are designed to stabilise the microwave under these hostile conditions to maintain intruder catch performance.

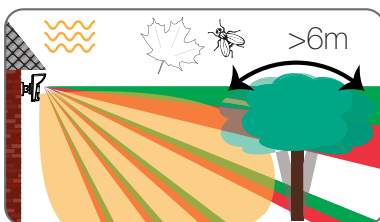

## Insect, Seasonal & Sunlight Protection

The XD detectors are designed to differentiate between actual intruders and natural occurrences such as rain, snow, falling leaves, small insects and bright sunlight.

## Adjustable Anti-Masking (Anti-Spray) Technology

This Pyronix patented technology offers masking protection, including anti-spray, for both PIR and microwave detectors. The anti-masking detection range is adjustable from 0-1m in front of the detector. Once the protected area has been breached and any of the technologies are masked with substances like paper, sprays, lacquers, sellotape, cardboard boxes, aluminum foil etc. the Detectors will enter into a mask condition; activating a dedicated separate mask relay.

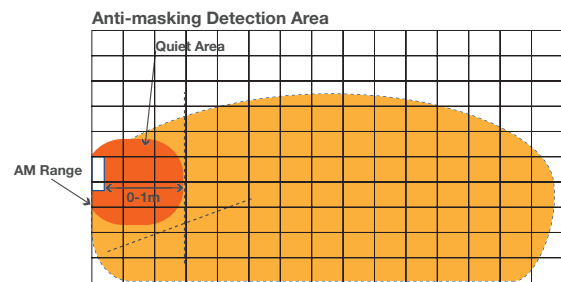

## Blocking Detection Technology

This Pyronix patented technology recognises when the detector has been intentionally or accidentally blocked by objects such as cardboard boxes and will automatically send a signal to the alarm panel telling the system that the detector is blocked. As a result, you will not be able to set the system until the blockage has been removed.



## Heavy Duty Ultra Violet Filter

Ultra violet light is always present in our environment and is particularly strong at high altitude and seaside locations. Exposure to high UV radiation reduces performance and can fully blind the PIR sensors. To protect against this, the XD lenses are manufactured with an ultraviolet stabilising material to ensure that their detection capability is not effected by UV radiation.

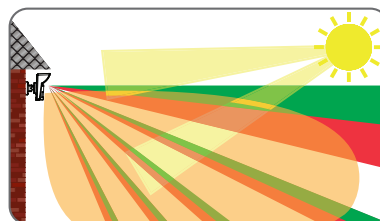

# XD Features



XDH10TT-AM



XDL15TT-AM

Detection Range	10m, 90° Volumetric Coverage	15m, 14° Narrow Beam Perimeter Coverage
Installation Height	2.4m	1.2m
Animal Immunity	<10kg	<25kg
Tri-Signal Detection Logic	✓	✓
Anti-Masking (Anti-Spray) Technology	✓	✓
Blocking Detection Technology	✓	✓
Additional NO Control Output Relay	✓	✓
Built in End of Line Resistors	Alarm / Tamper / Mask / Fault	
Microwave Module Frequencies	9.87 GHz, 9.90 GHz, 9.91 GHz	
PIR Technology	Two Independent PIR Sensors	
Built in Walk Test Buzzer	✓	✓
Digital Temperature Compensation	✓	✓
Vegetation Sway Elimination Filter	✓	✓
Sunlight Protection	✓	✓
Heavy Duty Ultra Violet Filter	✓	✓
Polycarbonate Housing	✓	✓
Sealed Optics	✓	✓
Conformal Coated PCB	✓	✓
Warranty	5 years	
Power Consumption	24mA @ 13.8VDC	
Relay Output	3x SELV limits; 60Vdc 50mA (43.4VA peak)	
Tamper Switch	12Vdc 50mA Front and rear	
Current Consumption Operating / Alarm	23mA / 30mA	
Relay	Alarm, Tamper, Mask / Fault	
Voltage	9-16Vcc, 13.8Vcc - 13.8Vcc Normal	
Immunity to RFI Modulated Wave (AM) and Pulse Modulated (PM) 80-2700MHz	25 V/m	
Immunity to RFI Continuous Wave (CW) 80-2700MHz	75 V/m	
Microwave Frequencies PTT	9.87 GHz / 9.90 GHz / 9.91 GHz	
Filter to Direct Light	>6500 Lux	
Weather Protection Level	IP55	
Detection Speed	0.25 - 3 m/s	
Operating temperature   storage	-30/+50   -40/+70	
Weight	300g	
Dimensions	118 x 77 x 84mm	

# Optional Accessories



## XD-WALLBRACKET

This bracket is adjustable 45 degrees left and right to optimise the volumetric coverage of the protected area.

The bracket kit includes stainless steel wall screws, a wall tamper and fixing template. All cables are hidden within the bracket for maximum security.

Suitable for use with the XDH volumetric detectors.

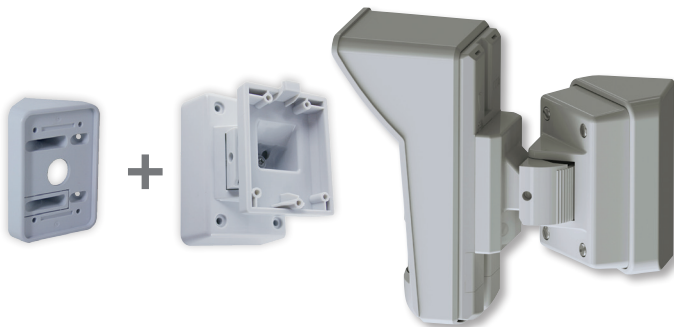

## XD-45D-ADAPTER

This accessory is designed for use with the XD-WALLBRACKET. It adds additional 45 degrees to the XD-WALLBRACKET that allows the bracket coverage to become 90 degrees. Such a solution is normally used with curtain or perimeter detectors protecting wall or fence.

The bracket includes stainless steel fixing screws.

Combining with the XD-WALLBRACKET it is suitable for use with both the XDH10TT-AM and XDL15TT-AM detectors.



## XD-FIXEDBRACKET

The fixed bracket combines bracket and container to accommodate various accessories such as mini power supplies, batteries, etc. On this bracket it is possible to mount of up to two detectors, one on each side. It is designed to ensure the optimum optical performance of curtain and perimeter XD variants when mounted on a wall.

Suitable for use with both XDL15TT-AM and XDH10TT-AM.

# EOL Resistors

Built into the XD detectors is a wide selection of end of line resistors for the alarm, mask and fault meaning the values can be set simply during installation and do not need to be wired in. This allows for ease and speed of install.

Mask/Fault	1K*	2K2	4K7	5K6	6K8	8K2	12K	15K	3K	
Tamper	1K*	1K5	2K2	2K7	3K9	4K7	5K6	10K		
Alarm	820R	1K	1K5	2K2	2K7	3K9	4K7	5K6	6K8*	10K

\*Factory preset

## Changing EOL values

Simply move the jumper into the resistor value required for the type of control panel used.

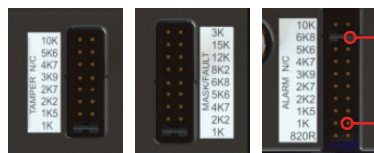

Install **without** limits



www.pyronix.com  
marketing@pyronix.com  
Pyronix Ltd., Secure House, Braithwell Way,  
Hellaby, Rotherham, S66 8QY, UK

